

BNC Connector Series

KLS1-BNC002 BNC Connector Series

Electrical Specifications

Impedance: 50 Ω nominal
 Frequency Range: 0-4 GHz with low reflection
 Voltage Rating: 500 volts peak
 Dielectric Withstanding Voltage: 1,500 volts rms
 VSWR :Straight connectors: 1.3 max 0-4 GHz
 Right angle connectors: 1.35 max 0-4 GHz
 Contact Resistance
 Center contact: 1.5 mΩ;
 Outer contact: 0.2 mΩ
 Insulation Resistance: 5,000 MΩ
 Braid to Body: 0.1 milliohm
 RF Leakage: -55 dB min at 3 GHz
 Insertion Loss: 0.2 dB min at 3 Ghz
 Temperature Range: - 65°C to + 165°C

Material

Male Contact: Brass
 Female Contact: Beryllium copper or phosphorous bronze, silver or gold-plated
 Other Metal Parts: Brass, nickel finish
 Insulator: TFE
 Crimp Ferrule: Copper/brass

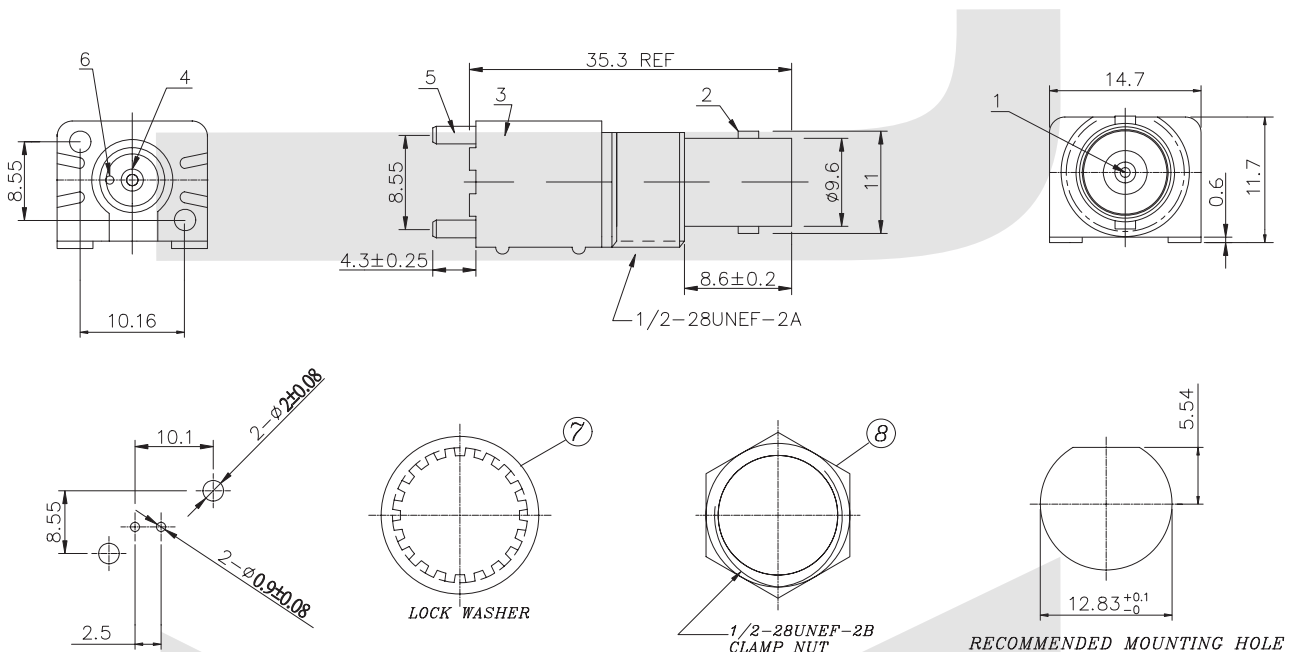

ORDER INFORMATION

Product NO.: KLS1-BNC002

Pos. NO. _____
 BNC Connector Type _____