

## Stereo Jack Series

### KLS1-SJO3.5-002 (Stereo Jack/OPTO)

#### Technical parameters:

Rated voltage: DC 30 V  
 Rated current: 0.5 A  
 Contact resistance: 0.03Ω, max  
 Insulation resistance: 100MΩ, min  
 Pressure: AC500V (50Hz) / 1minute  
 Insertion Force :2-20 N  
 Life: 50000 times  
 Operating Temperature:-30°C ~ 70°C

#### Material:

Terminal 1 : Copper Alloy  
 Terminal 2 : Copper Alloy  
 Terminal 3 : Copper Alloy  
 Terminal 4 : Copper Alloy  
 Terminal 5 : Copper Alloy  
 Shield : Brass  
 Housing-1/2,Cover : PA9T

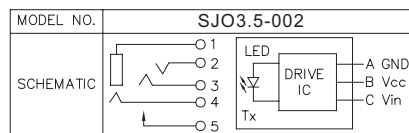
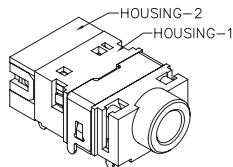
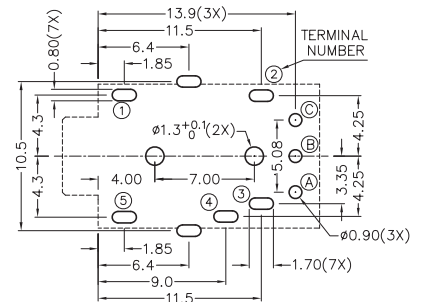
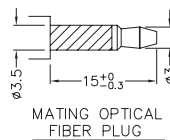
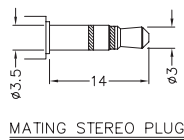
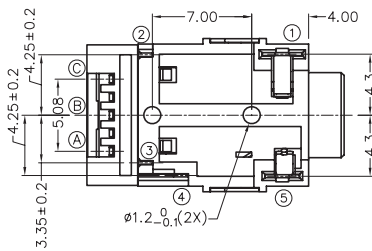
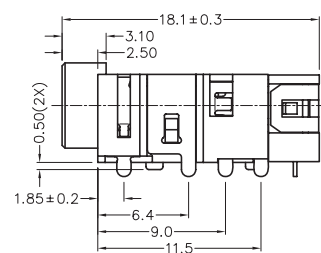
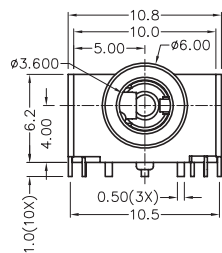
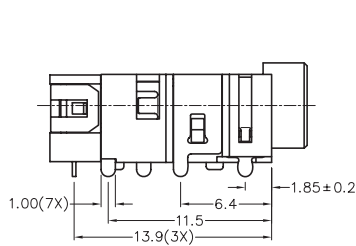

## ORDER INFORMATION

Product NO.: KLS1-SJO3.5-002

Pos. NO. ————  
 3.5mm Stereo Jack/OPTO ————