

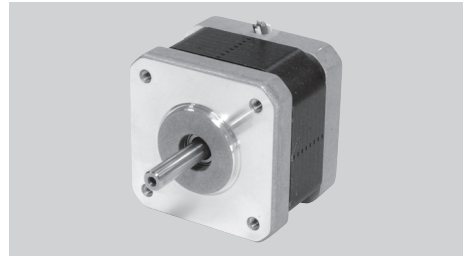

KLS23-17HE SERIES 3.6°

Key Features

- High Speed
- Low Inertia
- High Acceleration



General Specifications

- Bi-polar

Series & Length	Model Number	Holding Torque		Rated Current	Resistance per Phase	Inductance per Phase	Detent Torque		Rotor Inertia	
		mNm	oz-in	A	ohm	mH	mNm	oz-in	g.cm ²	oz-in ²
17HE1 34.3 mm (1.35 in.)	17HE1401-01	115	16.30	0.58	12	9.4	15	2.12	20	0.11
	17HE1402-01	115	16.30	0.16	150	100				
	17HE1403-01	120	17.01	2.5	0.85	0.7				

- Uni-polar

Series & Length	Model Number	Holding Torque		Rated Current	Resistance per Phase	Inductance per Phase	Detent Torque		Rotor Inertia	
		mNm	oz-in	A	ohm	mH	mNm	oz-in	g.cm ²	oz-in ²
17HE1 34.3 mm (1.35 in.)	17HE1603-02	88	12.47	0.2	75	35	15	2.12	20	0.11
	17HE1604-01	88	12.47	0.25	50	25				
	17HE1606-02	88	12.47	0.58	12	5.5				

- Wiring Connection, Lead Wires, Schematic Diagrams & Stepping Sequence.....Page 62 - 64

Mechanical Dimension

Series	L	Mass
	mm (in.)	kg (lb.)
17HE1	34.3 (1.35)	0.2 (0.44)

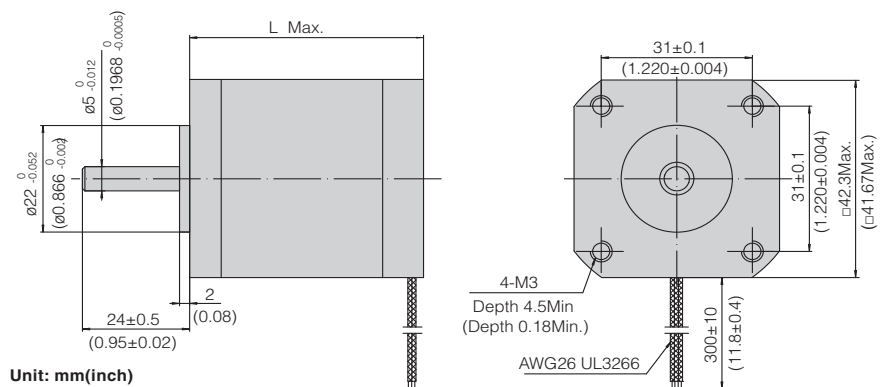



Dynamic Torque Curves

- Bi-polar

17HE1401-01

Conditions:Bi-polar Constant Current Driver
Driver: AMA MS3540M
Mode:Full Step

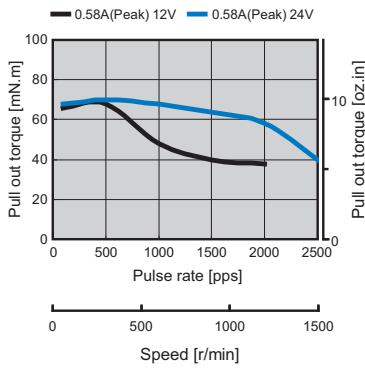

17HE1402-01

Conditions:Bi-polar Constant Current Driver
Driver: AMA MS3540M
Mode:Full Step

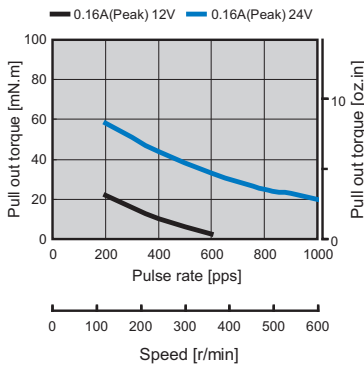

17HE1403-01

Conditions:Bi-polar Constant Current Driver
Driver: AMA MS3540M
Mode:Full Step

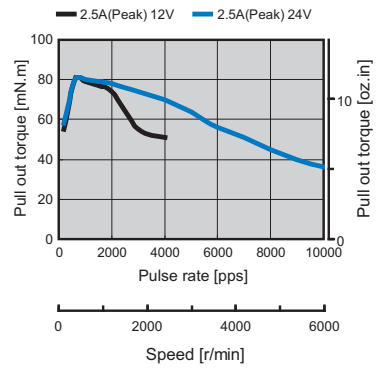

- Uni-polar

17HE1603-02

Conditions:Uni-polar Constant Current Driver
Driver: AMA MSU3040M
Mode:Full Step

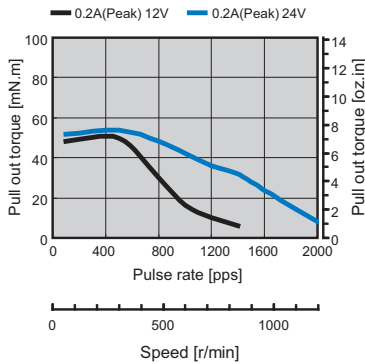

17HE1604-01

Conditions:Uni-polar Constant Current Driver
Driver: AMA MSU3040M
Mode:Full Step

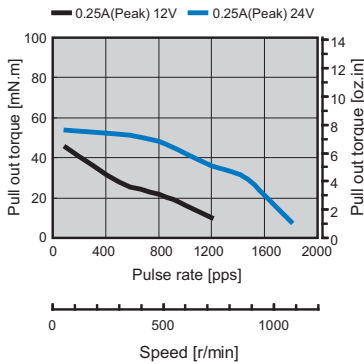

17HE1606-02

Conditions:Uni-polar Constant Current Driver
Driver: AMA MSU3040M
Mode:Full Step

