

HF141FF

MINIATURE HIGH POWER RELAY



File No.:E133481



File No.:CQC09002034351



Features

- 10A switching capability
- 5kV dielectric strength (between coil and contacts)
- Sockets available
- 1 Form A, 1 Form B and 1 Form C configurations
- Plastic sealed and flux proofed types available
- Environmental friendly product (RoHS compliant)
- Outline Dimensions: (29.0 x 12.6 x 20.6) mm

CONTACT DATA

Contact arrangement	1A, 1B, 1C	
Contact resistance	50mΩ max.(at 1A 6VDC)	
Contact material	AgSnO ₂ , AgCdO	
Contact rating (Res.load)	Standard	High Capacity
	8A 250VAC /30VDC 10A 125VAC	10A 30VDC 10A 250VAC
Max. switching power	2000VA / 240W	2500VA / 300W
Max. switching current	10A	
Max. switching voltage	250VAC / 30VDC	
Mechanical endurance	1 x 10 ⁷ ops	
Electrical endurance	Standard type: 1 x 10 ⁵ ops (NO or NC, 8A 250VAC/30VDC, Resistive load, Room temp., 1s on 9s off),	
	High capacity type: 1 x 10 ⁵ ops (NO or NC, 10A 250VAC/30VDC, Resistive load, Room temp., 1s on 9s off),	

CHARACTERISTICS

Insulation resistance	1000MΩ (at 500VDC)	
Dielectric strength	Between coil & contacts	5000VAC 1min
	Between open contacts	1000VAC 1min
Operate time (at nomi. volt.)	15ms max.	
Release time (at nomi. volt.)	5ms max.	
Vibration resistance	10Hz to 55Hz 1.5mm DA	
Shock resistance	Functional	98m/s ²
	Destructive	980m/s ²
Humidity	5% to 85% RH	
Ambient temperature	-40°C to 70°C	
Termination	PCB	
Unit weight	Approx. 13g	
Construction	Plastic sealed, Flux proofed	

- Notes:** 1) The data shown above are initial values.
2) Please find coil temperature curve in the characteristic curves below.
3) UL insulation system: Class A

COIL

Coil power	Standard: Approx. 720mW; Sensitive: Approx. 550mW
------------	--

COIL DATA

at 23°C

Standard type

Nominal Voltage VDC	Pick-up Voltage VDC max.	Drop-out Voltage VDC min.	Max. Voltage VDC*	Coil Resistance Ω
5	4.0	0.5	6.5	36 x (1±10%)
6	4.8	0.6	7.8	50 x (1±10%)
9	7.2	0.9	11.7	115 x (1±10%)
12	9.6	1.2	15.6	200 x (1±10%)
18	14.4	1.8	23.4	460 x (1±10%)
24	19.2	2.4	31.2	820 x (1±10%)
48	38.4	4.8	62.4	3300 x (1±10%)

Sensitive type

Nominal Voltage VDC	Pick-up Voltage VDC max.	Drop-out Voltage VDC min.	Max. Voltage VDC*	Coil Resistance Ω
5	4.0	0.5	6.5	47 x (1±10%)
6	4.8	0.6	7.8	68 x (1±10%)
9	7.2	0.9	11.7	155 x (1±10%)
12	9.6	1.2	15.6	270 x (1±10%)
18	14.4	1.8	23.4	620 x (1±10%)
24	19.2	2.4	31.2	1100 x (1±10%)
48	38.4	4.8	62.4	4400 x (1±10%)

- Notes:** 1) When requiring pick-up voltage < 80% of nominal voltage, special order allowed.
2) *Maximum voltage refers to the maximum voltage which relay coil could endure in a short period of time.



HONGFA RELAY

ISO9001, ISO/TS16949, ISO14001, OHSAS18001, IECQ QC 080000 CERTIFIED

2014 Rev. 1.01

SAFETY APPROVAL RATINGS

UL/CUL	High Capacity	10A 30VDC/250VAC
	Standard	8A 30VDC/250VAC 10A 125VAC

Notes: 1) All values unspecified are at room temperature.

2) Only typical loads are listed above. Other load specifications can be available upon request.

ORDERING INFORMATION

Type	HF141FF / 012 -H S P G (XXX)		
Coil voltage	5, 6, 9, 12, 18, 24, 48VDC		
Contact arrangement	H:1 Form A	D:1 Form B	Z:1 Form C
Construction ¹⁾	S: Plastic sealed	Nil: Flux proofed	
Coil power	P: Standard	Nil: Sensitive	
Contact capacity	G: High capacity (AgSnO ₂)	Nil: Standard type (AgCdO)	
Customer special code			

Notes: 1) Under the ambience with dangerous gas like H₂S, SO₂ or NO₂, plastic sealed type is recommended; Please test the relay in real applications. If the ambience allows, flux proofed type is preferentially recommended.

2) Contact is recommended for suitable condition and specifications if water cleaning or surface process is involved in assembling relays on PCB.

OUTLINE DIMENSIONS, WIRING DIAGRAM AND PC BOARD LAYOUT

Unit: mm

Outline Dimensions

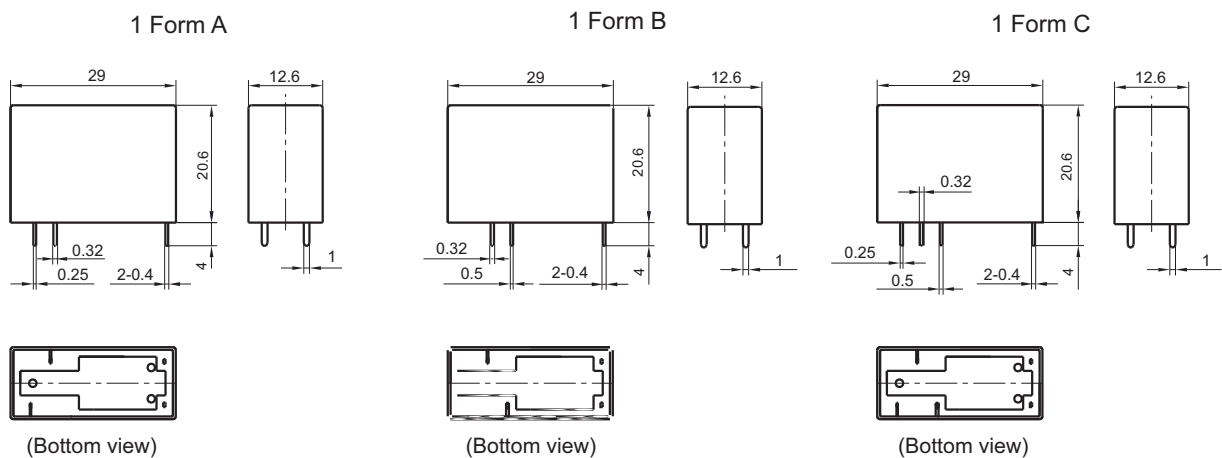

Remark: 1) In case of no tolerance shown in outline dimension: outline dimension ≤ 1 mm, tolerance should be ± 0.2 mm; outline dimension > 1 mm and ≤ 5 mm, tolerance should be ± 0.3 mm; outline dimension > 5 mm, tolerance should be ± 0.4 mm.

2) The tolerance without indicating for PCB layout is always ± 0.1 mm.

OUTLINE DIMENSIONS, WIRING DIAGRAM AND PC BOARD LAYOUT

Unit: mm

PCB Layout (Bottom view)

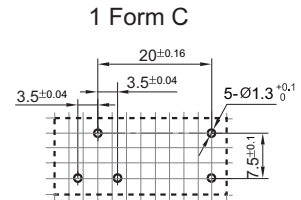
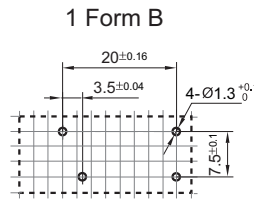
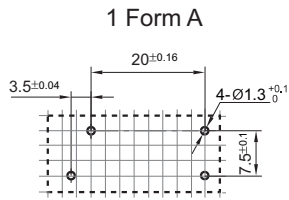

Remark: The width of the gridding is 2.5mm.

Wiring Diagram (Bottom view)



CHARACTERISTIC CURVES

MAXIMUM SWITCHING POWER

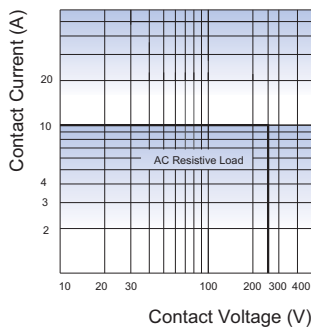

ENDURANCE CURVE

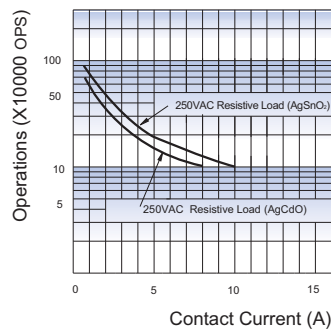

COIL TEMPERATURE RISE

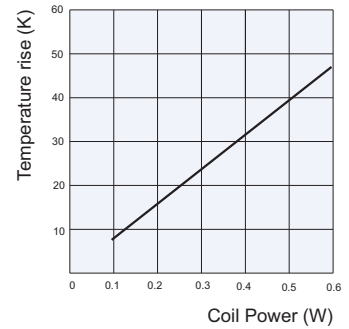

Test conditions:

No contact, Resistive load,
Flux proofed, Room temp., 1s on 9s off.

Disclaimer

The specification is for reference only. See to "Terminology and Guidelines" for more information. Specifications subject to change without notice. We could not evaluate all the performance and all the parameters for every possible application. Thus the user should be in a right position to choose the suitable product for their own application. If there is any query, please contact Hongfa for the technical service. However, it is the user's responsibility to determine which product should be used only.