

HF105F-1

MINIATURE HIGH POWER RELAY



File No.:E134517



File No.:40025518 (DC type)



File No.:CQC09002031229(DC type)



Features

- 40A switching capability
- 4kV dielectric strength (between coil and contacts)
- Heavy load up to 7,200VA
- PCB coil terminals, ideal for heavy duty load
- Unenclosed, Plastic sealed and dust protected types available
- UL insulation system: Class F available
- Environmental friendly product (RoHS compliant)
- Outline Dimensions: (32.3 x 27.1x 20.0) mm

CONTACT DATA

Contact arrangement	1A	1B	1C (NO)	1C (NC)
Contact resistance	50mΩ max. (at 1A 24VDC)			
Contact material	AgSnO ₂ , AgCdO			
Max. switching capacity	7200VA/560W	3600VA/280W	4800VA/560W	2400VA/280W
Max. switching voltage	277VAC / 28VDC			
Max. switching current	40A	15A	20A	10A
HF105F-1 rating	30A 240VAC 20A 28VDC	15A 240VAC 10A 28VDC	20A 240VAC 20A 28VDC	10A 240VAC 10A 28VDC
HF105F-1L rating	25A 240VAC 20A 28VDC	15A 240VAC 10A 28VDC	20A 240VAC 20A 28VDC	10A 240VAC 10A 28VDC
Mechanical endurance	1 x 10 ⁷ OPS			
Electrical endurance	1H type: 1 x 10 ⁵ OPS (28A 277VAC, Resistive load, AgCdO, Room temp., 1s on 9s off)			

CHARACTERISTICS

Insulation resistance	1000MΩ (at 500VDC)	
Dielectric strength	Between coil & contacts	2500VAC/4000VAC 1min
	Between open contacts	1500VAC 1min
Operate time (at nomi. volt.)	DC type: 15ms max.	
Release time (at nomi. volt.)	DC type: 10ms max.	
Ambient temperature	DC: -55°C to 85°C AC: -55°C to 60°C	
Shock resistance	Functional	98m/s ²
	Destructive	980m/s ²
Vibration resistance	10Hz to 55Hz 1.5mm DA	
Humidity	5% to 85% RH	
Termination	PCB	
Unit weight	Approx.36g	
Construction	Unenclosed (Only for DC coil), Plastic sealed, Dust protected	

- Notes:** 1) For plastic sealed type, the venting-hole should be excised in test.
 2) The data shown above are initial values.
 3) Please find coil temperature curve in the characteristic curves below.
 4) UL insulation system: Class F, Class B.

COIL

Coil power	DC type: Approx. 900mW; AC type: Approx. 2VA
------------	---

SAFETY APPROVAL RATINGS

UL / CUL	1 Form A	AgSnO ₂	30A 277VAC 40A 277VAC 2HP 250VAC 1HP 125VAC
		AgCdO	30A 28VDC 28A 277VAC 277VAC(FLA=20)(LRA=60)
	1 Form B	AgCdO	15A 277VAC 10A 28VDC 1/2HP 250VAC 1/4HP 125VAC 277VAC(FLA=10)(LRA=33)
		NO	AgSnO ₂
	1 Form C		AgCdO
		NC	AgSnO ₂
AgCdO	10A 277VAC 10A 28VDC 277VAC(FLA=10)(LRA=33)		

- Notes:** 1) All values unspecified are at room temperature.
 2) Only typical loads are listed above. Other load specifications can be available upon request.



HONGFA RELAY

ISO9001, ISO/TS16949, ISO14001, OHSAS18001, IECQ QC 080000 CERTIFIED

2014 Rev. 1.01

COIL DATA

at 23°C

DC type

Nominal Voltage VDC	Pick-up Voltage VDC max.	Drop-out Voltage VDC min.	Max. Voltage VDC *	Coil Resistance Ω
5	3.75	0.5	6.5	27 x (1±10%)
6	4.50	0.6	7.8	40 x (1±10%)
9	6.75	0.9	11.7	97 x (1±10%)
12	9.00	1.2	15.6	155 x (1±10%)
15	11.25	1.5	19.5	256 x (1±10%)
18	13.50	1.8	23.4	380 x (1±10%)
24	18.00	2.4	31.2	660 x (1±10%)
48	36.00	4.8	62.4	2560 x (1±10%)
70	52.50	7.0	91	5500 x (1±10%)
110	82.50	11	143	13450 x (1±10%)

AC type

Nominal Voltage VAC	Pick-up Voltage VAC max.	Drop-out Voltage VAC min.	Max. Voltage VDC *	Coil Resistance Ω
12	9.6	2.4	15.6	25 x (1±10%)
24	19.2	4.8	31.2	100 x (1±10%)
120	96.0	24.0	156	2500 x (1±10%)
208	166.4	41	270.4	11000 x (1±10%)
220	176	44	286	13490 x (1±10%)
240	192	48	286	13490 x (1±10%)
277	220	54	360.1	15000 x (1±10%)

- Notes:**
- 1) When requiring pick-up voltage < 80% of nominal voltage, special order allowed.
 - 2) The data shown above are initial values at 50Hz. When requiring 60Hz, special order allowed.
 - 3) *Maximum voltage refers to the maximum voltage which relay coil could endure in a short period of time.

ORDERING INFORMATION

HF105F-1 / 018 D T -1H S T F (XXX)

Type

HF105-1: 30A (Unenclosed, only for DC coil)
 HF105-1L: 25A (Unenclosed, only for DC coil)
 HF105F-1: 30A
 HF105F-1L: 25A

Coil voltage

DC: 5VDC to 110VDC
AC: 12VAC to 277VAC

Coil voltage form

D: DC **A:** AC

Termination

6 : With Pin NO.6, Dielectric Strength Between Coil and Contact: 2500VAC
T : Without Pin NO.6, Dielectric Strength Between Coil and Contact: 4000VAC
Nil: Without Pin NO.6, Dielectric Strength Between Coil and Contact: 2500VAC

Contact arrangement

1H: 1 Form A **1D:** 1 Form B **1Z:** 1 Form C

Construction¹⁾²⁾

S: Plastic sealed
Nil: Dust protected (For HF105F-1, HF105F-1L)
 Unenclosed (For HF105-1, HF105-1L)

Contact material

T: AgSnO₂ **Nil:** AgCdO

Insulation standard

F: Class F **Nil:** Class B

Customer special code

Notes: 1) We recommend dust protected types for a clean environment (free from contaminations like H₂S, SO₂, NO₂, dust, etc.).

We suggest to choose plastic sealed types and validate it in real application for an unclean environment (with contaminations like H₂S, SO₂, NO₂, dust, etc.).

- 2) Contact is recommended for suitable condition and specifications if water cleaning or surface process is involved in assembling relays on PCB.

HF105F-1

1 Form A

Outline Dimensions

Wiring Diagram
(Bottom view)

PCB Layout
(Bottom view)

With 6# terminal

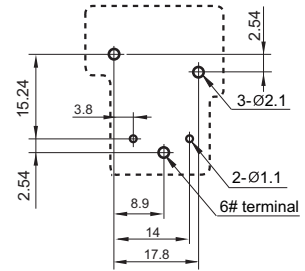
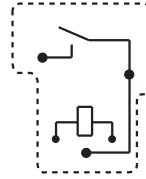
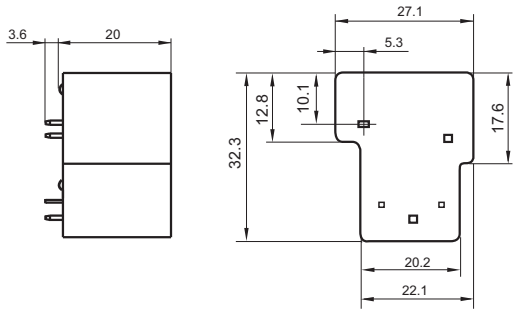

Without 6# terminal

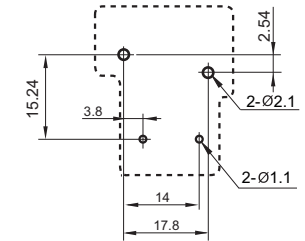
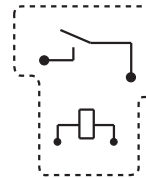
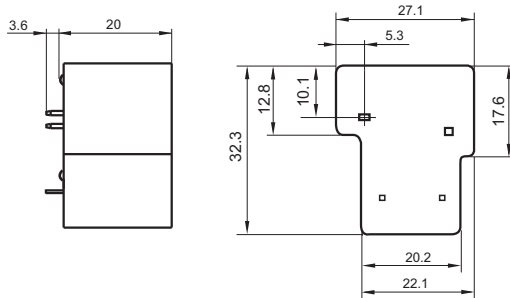

1 Form B

With 6# terminal

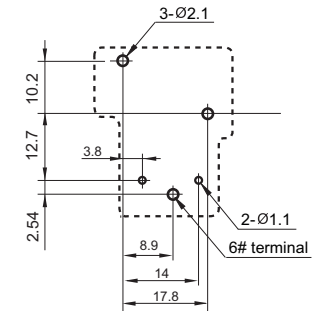
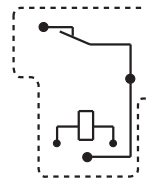
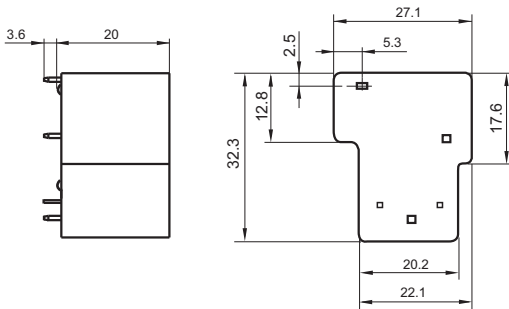

Without 6# terminal

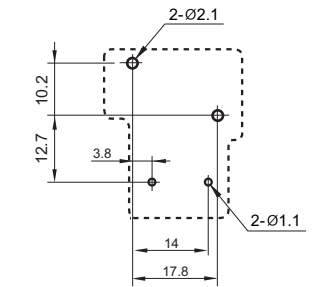
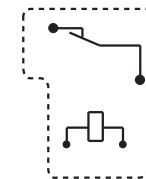
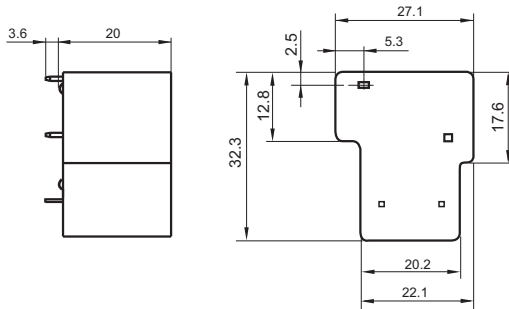

OUTLINE DIMENSIONS, WIRING DIAGRAM AND PC BOARD LAYOUT

Unit: mm

1 Form C

Outline Dimensions

Wiring Diagram (Bottom view)

PCB Layout (Bottom view)

With 6# terminal

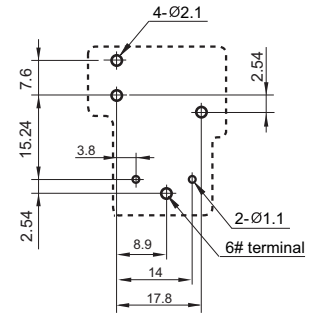
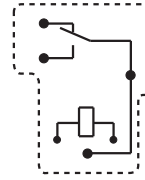
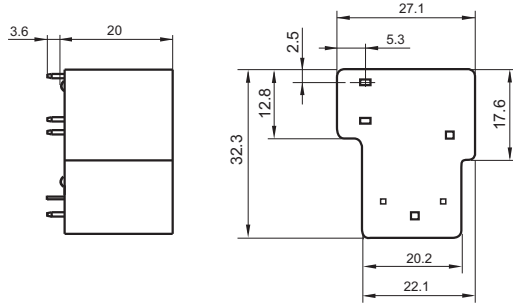

Without 6# terminal

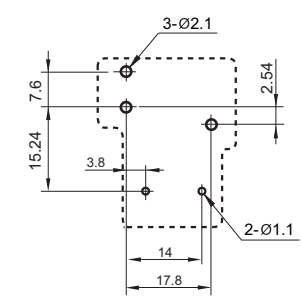
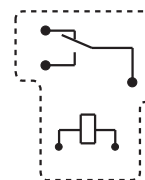
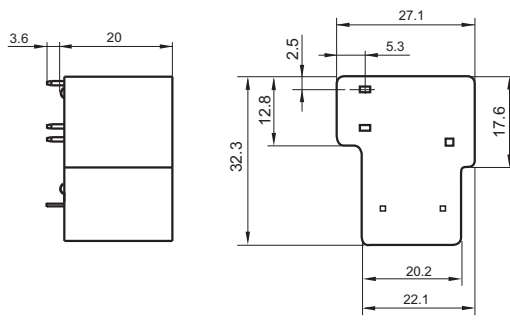

HF105-1

1 Form A

With 6# terminal

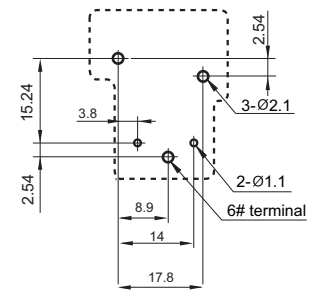
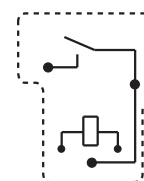
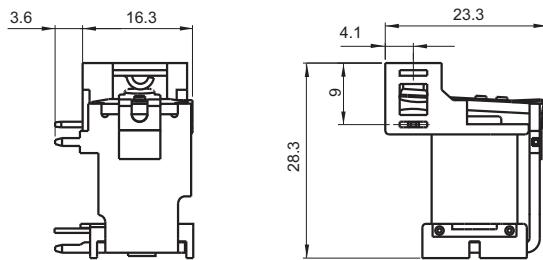

Without 6# terminal

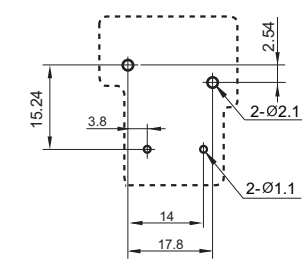
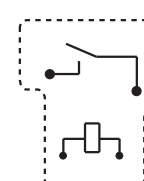
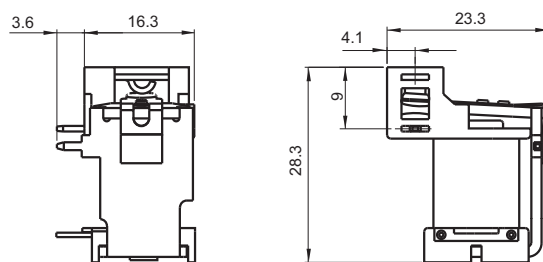

OUTLINE DIMENSIONS, WIRING DIAGRAM AND PC BOARD LAYOUT

Unit: mm

1 Form B

Outline Dimensions

With 6# terminal

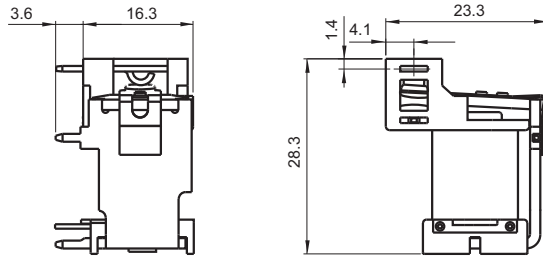

Wiring Diagram (Bottom view)

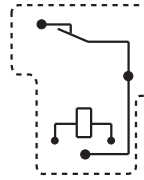

PCB Layout (Bottom view)

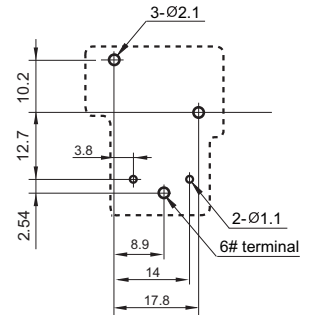

Without 6# terminal

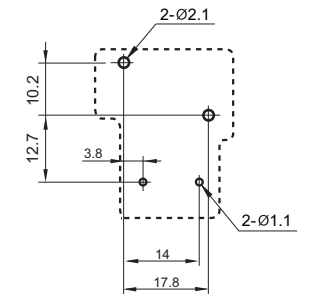
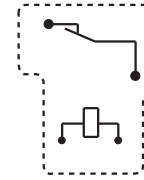
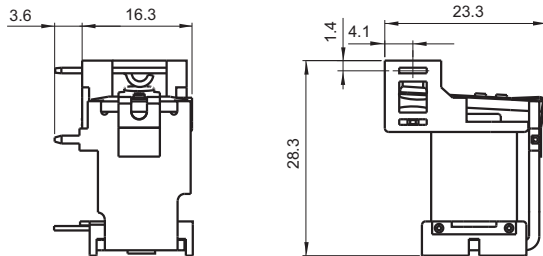

1 Form C

With 6# terminal

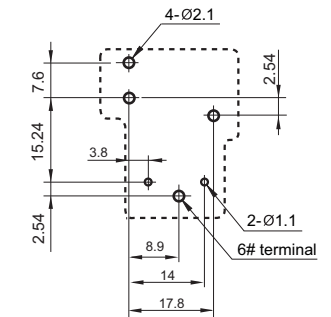
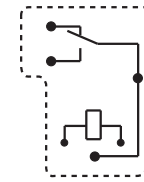
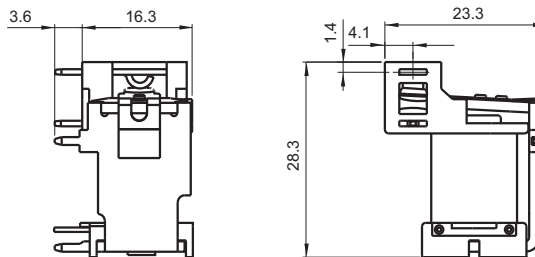

Without 6# terminal

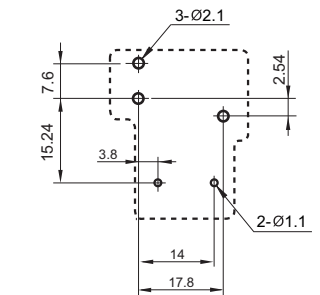
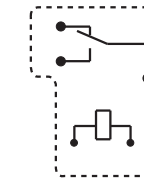
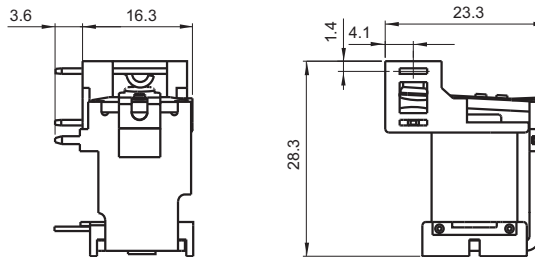

- Remark: 1) In case of no tolerance shown in outline dimension: outline dimension $\leq 1\text{mm}$, tolerance should be $\pm 0.2\text{mm}$; outline dimension $> 1\text{mm}$ and $\leq 5\text{mm}$, tolerance should be $\pm 0.3\text{mm}$; outline dimension $> 5\text{mm}$, tolerance should be $\pm 0.4\text{mm}$.
 2) The tolerance without indicating for PCB layout is always $\pm 0.1\text{mm}$.

CHARACTERISTIC CURVES

MAXIMUM SWITCHING POWER

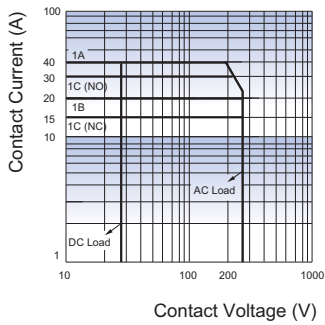

ENDURANCE CURVE

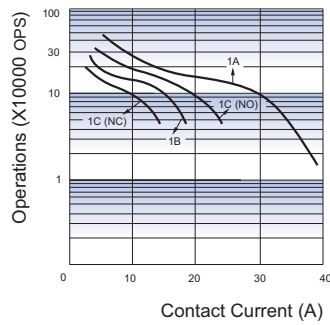

COIL TEMPERATURE RISE

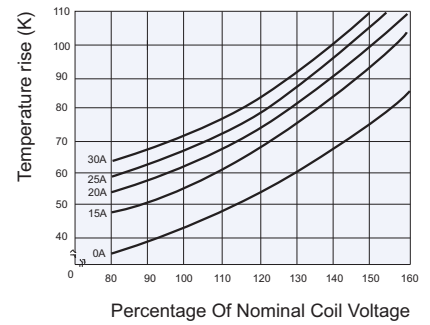

Test conditions:

Resistive load, Dust protected,
AgCdO, Room temp., 1s on 9s off.

Disclaimer

The specification is for reference only. See to "Terminology and Guidelines" for more information. Specifications subject to change without notice. We could not evaluate all the performance and all the parameters for every possible application. Thus the user should be in a right position to choose the suitable product for their own application. If there is any query, please contact Hongfa for the technical service. However, it is the user's responsibility to determine which product should be used only.