



**AC Power Sockets\*AC Plugs**

KLS1-AS-301-15 AC Power Sockets\*AC Plugs

**Material:**

Material(External): Nylon PA66 PC  
 Rating Voltage: 250V 10A  
 Humidity: 93%+40  
 Insulation:  $\geq 100M\Omega$   
 Withstand Voltage: AC 500V(50Hz)/min

**Electrical Characteristics:**

Conduct Material: COPPER  
 Temperature Range:  $-40^{\circ}C + 70^{\circ}C$   
 Contact Resistance:  $\leq 0.03\Omega$   
 Actuating Force: 5-40N  
 Lifespan: 10000times

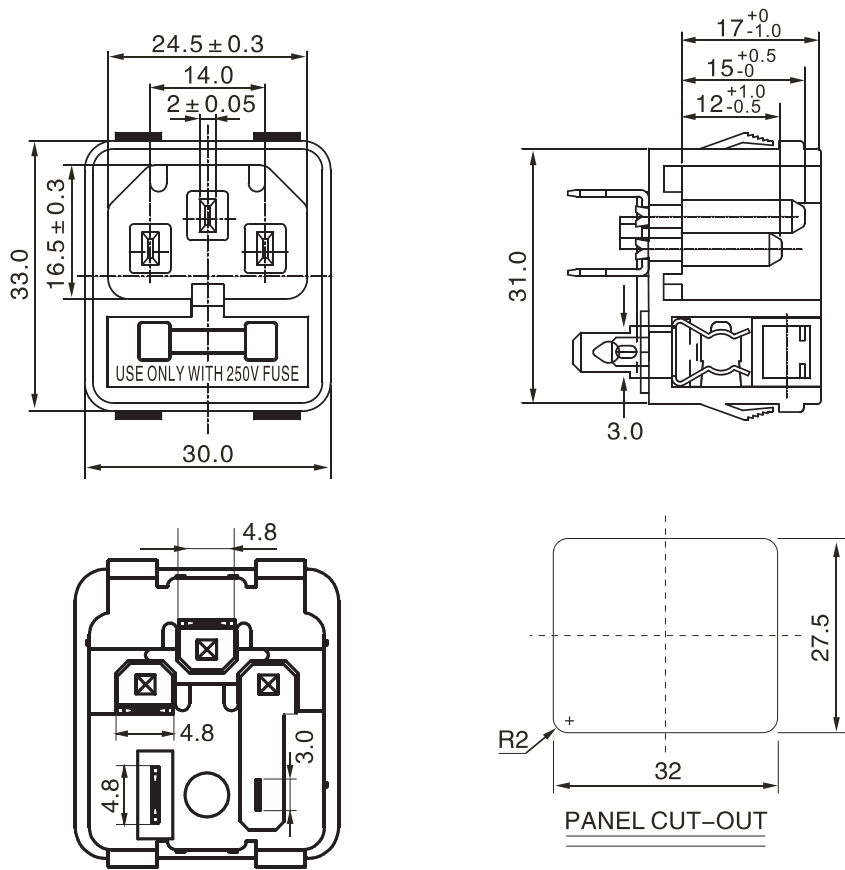

**ORDER INFORMATION**

Product NO.: KLS1-AS-301-15

