

10/100 Base-Tx Transformer Modules

Electrical Specification:

@25°C Operating Temperature 0 to +70°C

Part NO : 1216M-S001LF
 Trun Ratio (±3%) : TX 1CT:1CT
 RX 1CT:1CT

OCL primary@ 100KHz,0.1Vrms,8mA : 350uH Min

Leakage primary@ 10KHz,0.1Vrms : 0.5uH max

Cww (Pri.:Sec.) : 35pF Max

DCR (Ω): Primary 0.9 Max
 Secondary 1.2 Max

Insertion loss: 1-100MHz -1.0dB max

Return loss: 1-30MHz -18dB min
 40MHz -16dB min
 50MHz -16dB min
 60-100MHz -10dB min

DMRR : 1-60MHz -35dB min .

60-100MHz -30dB min .

Crosstalk: 1-100MHz -33dB min .

Isolation Voltage 1500 Vrms Min.

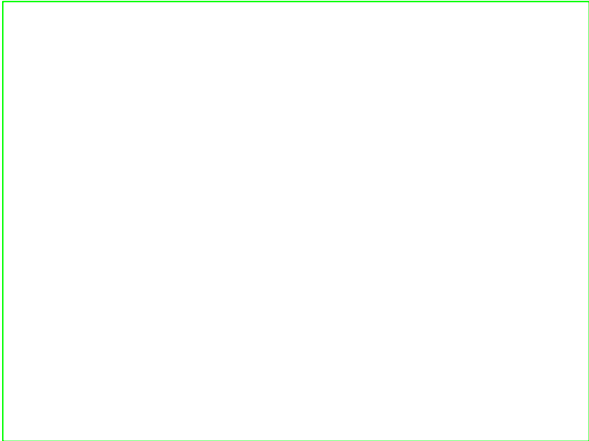

Schematic

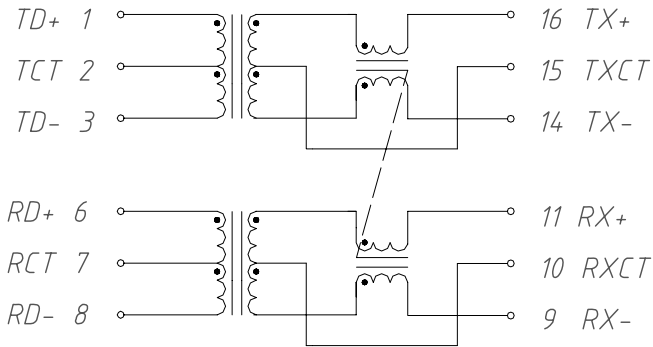

Features:

1. IEEE 802.3af/ANSI X3.263 compliant performance.
2. Operating Humidity:90%RH
3. Storage temperature range:-40~+80°C,90%RH
4. RoHS Compliant

Dimension: unit:mm

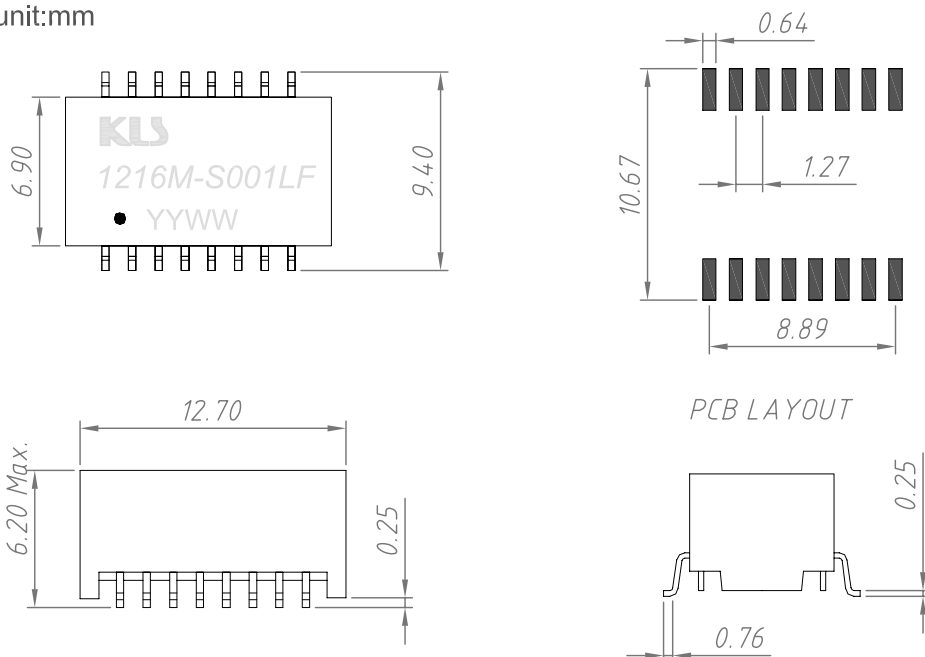

1216M-S001LF-T
 1216M-S001LF-R

Packing: Tube
 Packing: Tape&Reel