

## RJ45 with Transformer

KLS12-TL163 1000Base 1x1 Tab-Down RJ45

### Electrical Specifications:

- Insertion Loss: 1-100MHZ -1.0dB MAX
- Return Loss: 1-30MHZ -16.0dB MIN
- 30-60MHZ -14.0dB MIN
- 60-80MHZ -10.0dB MIN
- Cross Talk: 1-30MHZ -40.0dB MIN
- 30-60MHZ -35.0dB MIN
- 60-80MHZ -30.0dB MIN
- CMR: 1M-100MHZ -35dB MIN
- Hi-Pot: 1500v AC 6S 1mA
- OCL:350uH MIN @ 100KHZ 100mV 8mA DC
- Contacts: 0.35mm thick phos bronze plated with 6u' gold in contact area
- Turn Ratio: 1CT:1CT +/-3%
- Housing Material:PBT Black
- Operating temperature range:-40°C- +85°C

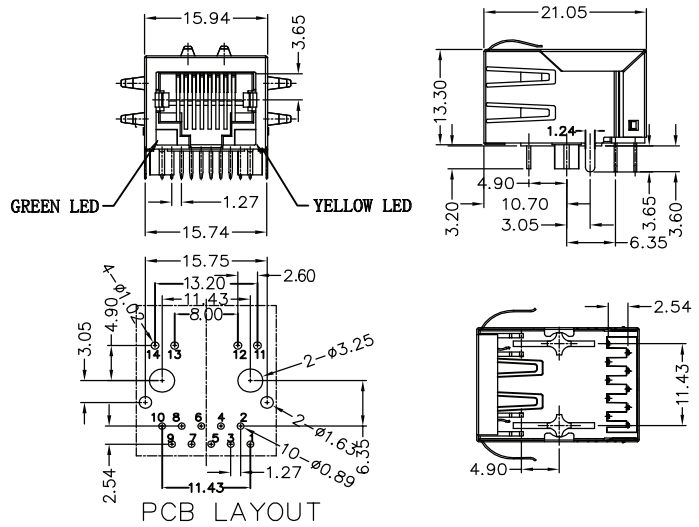
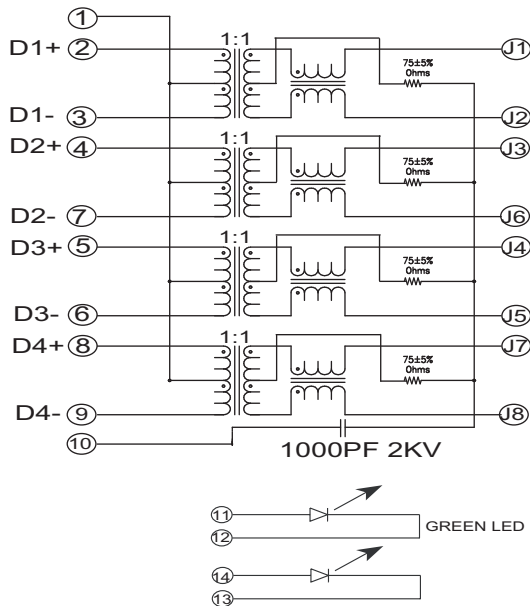

## ORDER INFORMATION

