

PACKAGE DIMENSION mm

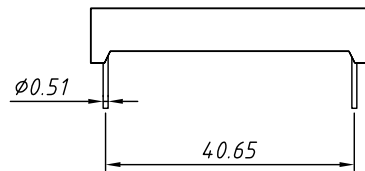

INTERNAL CIRCUIT DIAGRAM

Common Cathode
L-KLS9-D-15011 Ax

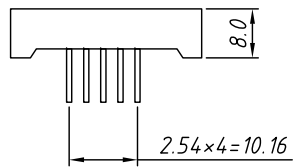
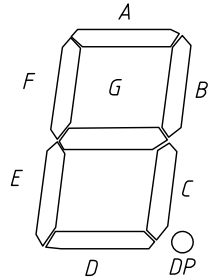
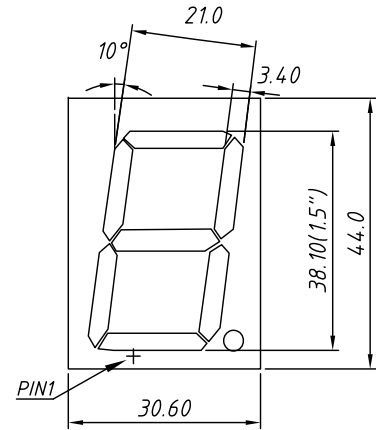
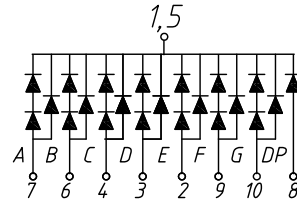

Common Anode
L-KLS9-D-15011 Bx

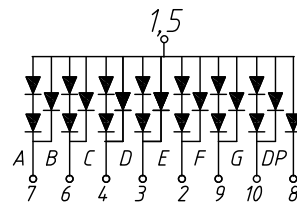

| Color Code | Emitting Color | Peak Wavelength | Forward Voltage V _F /Seg. | | Luminous Intensity I _v /Seg. | |
|------------|----------------|-----------------|--------------------------------------|------|---|------|
| | | | Typ. | Max. | Min. | Typ. |
| | | nm | V | | mcd | |
| UHR | Ultra Red | 640 | 2 | 2.5 | 40 | 60 |
| UE | Orange | 615 | 2 | 2.5 | 40 | 60 |
| H | Red | 623 | 2.25 | 2.5 | 0.4 | 0.8 |
| YO | Amber | 605 | 2 | 2.5 | 40 | 60 |
| UY | Yellow | 590 | 2 | 2.5 | 40 | 60 |
| UG | Green | 568 | 2.1 | 2.5 | 25 | 40 |
| PG | Pure Green | 525 | 3.3 | 3.8 | 150 | 200 |
| UB | Blue | 465 | 3.3 | 3.8 | 40 | 100 |
| UW | White | | 3.3 | 3.8 | 200 | 500 |

Electro/Optical Characteristics I_F=20mA Ta=25°C

Order information

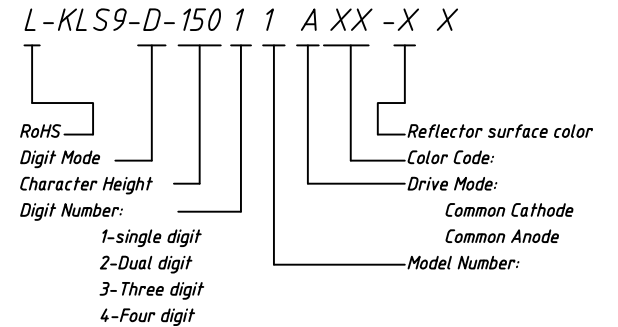

Maximum Ratings Ta=25°C (Derate above 25°C)

| Characteristic | Test Condition | Symbol | Units | Ultra Red | Orange | Red | Amber | Yellow | Green | Pure Green | Blue | White |
|--------------------------------|--------------------------------------|-----------------|-------|-----------|--------|------|-------|--------|-------|------------|-------|-------|
| | | | | UHR | UE | H | YO | UY | UG | PG | UB | UW |
| Pulse Forward Current Per Seg. | 1/10 duty cycle 0.1ms Pulse width | I _{FP} | mA | 100 | 100 | 50 | 100 | 100 | 100 | 100 | 100 | 100 |
| DC Forward Current Per Seg. | | I _F | mA | 30 | 30 | 15 | 30 | 30 | 30 | 30 | 30 | 30 |
| Reverse Current Per Seg. | V _R =5V | I _R | A | 10 | 10 | 10 | 10 | 10 | 10 | 10 | 10 | 10 |
| Power Dissipation | | P _D | mW | 65×8 | 65×8 | 40×8 | 65×8 | 65×8 | 75×8 | 110×8 | 120×8 | 120×8 |

| | | | |
|------------|-----------------------|--------------|---|
| Tolerance: | ±0.25mm unless stated | Description: | 1.5" Single Digit 7 Segment DISPLAYS |
| PROJECTION | | KLS P/N: | L-KLS9-D-15011XXXXX |
| UNITS | mm | | |
| SHEET SIZE | A4 | | NingBo KLS ELECTRONIC CO.,L TD. |
| Draw data | 2018-1-25 | | |
| Check data | 2018-1-25 | | |

PACKAGE DIMENSION mm

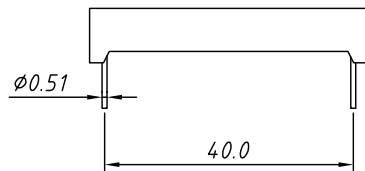
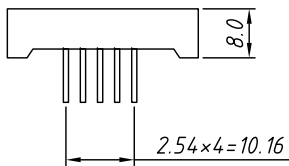
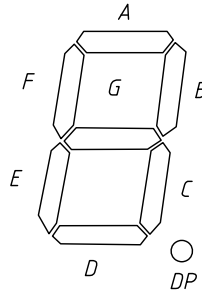
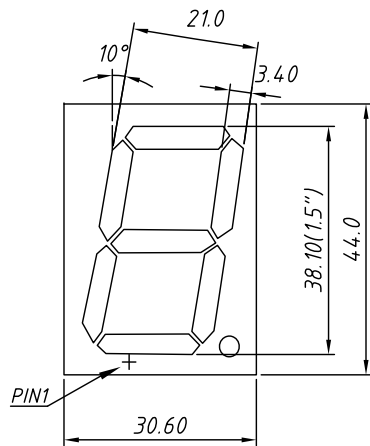

INTERNAL CIRCUIT DIAGRAM

Common Cathode
L-KLS9-D-15011 Cx

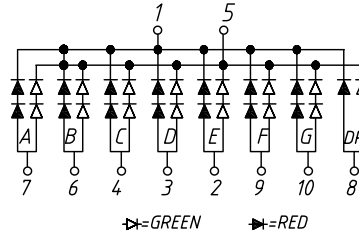

Common Anode
L-KLS9-D-15011 Dx

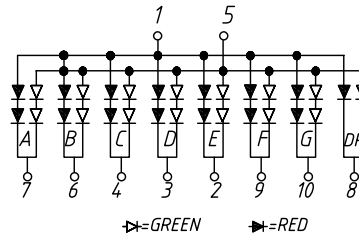

| Color Code | Emitting Color | Peak Wavelength | Forward Voltage V _F /Seg. | | Luminous Intensity I _v /Seg. | |
|------------|----------------|-----------------|--------------------------------------|------|---|------|
| | | | Typ. | Max. | Min. | Typ. |
| | | nm | V | | mcd | |
| UHR | Ultra Red | 640 | 2 | 2.5 | 40 | 60 |
| UE | Orange | 615 | 2 | 2.5 | 40 | 60 |
| H | Red | 623 | 2.25 | 2.5 | 0.4 | 0.8 |
| YO | Amber | 605 | 2 | 2.5 | 40 | 60 |
| UY | Yellow | 590 | 2 | 2.5 | 40 | 60 |
| UG | Green | 568 | 2.1 | 2.5 | 25 | 40 |
| PG | Pure Green | 525 | 3.3 | 3.8 | 150 | 200 |
| UB | Blue | 465 | 3.3 | 3.8 | 40 | 100 |
| UW | White | | 3.3 | 3.8 | 200 | 500 |

Electro/Optical Characteristics I_F=20mA Ta=25°C

Order information

L-KLS9-D-150 1 1 C XX -X X

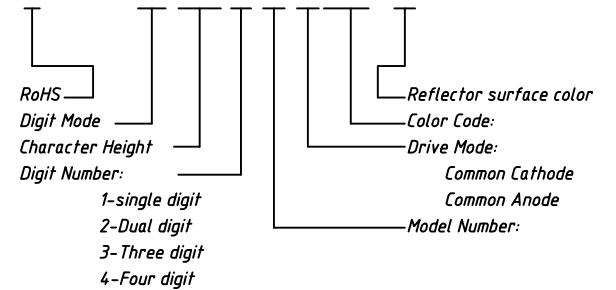

Maximum Ratings Ta=25°C (Derate above 25°C)

| Characteristic | Test Condition | Symbol | Units | Ultra Red | Orange | Red | Amber | Yellow | Green | Pure Green | Blue | White |
|--------------------------------|--------------------------------------|-----------------|-------|-----------|--------|------|-------|--------|-------|------------|-------|-------|
| | | | | UHR | UE | H | YO | UY | UG | PG | UB | UW |
| Pulse Forward Current Per Seg. | 1/10 duty cycle 0.1ms Pulse width | I _{FP} | mA | 100 | 100 | 50 | 100 | 100 | 100 | 100 | 100 | 100 |
| DC Forward Current Per Seg. | | I _F | mA | 30 | 30 | 15 | 30 | 30 | 30 | 30 | 30 | 30 |
| Reverse Current Per Seg. | V _R =5V | I _R | A | 10 | 10 | 10 | 10 | 10 | 10 | 10 | 10 | 10 |
| Power Dissipation | | P _D | mW | 65×8 | 65×8 | 40×8 | 65×8 | 65×8 | 75×8 | 110×8 | 120×8 | 120×8 |

| | | | |
|------------|-----------------------|--------------|---|
| Tolerance: | ±0.25mm unless stated | Description: | 1.5" Single Digit 7 Segment DISPLAYS |
| PROJECTION | | KLS P/N: | L-KLS9-D-15011XXXXX |
| UNITS | mm | | |
| SHEET SIZE | A4 | | NingBo KLS ELECTRONIC CO.,L TD. |
| Draw data | 2018-1-25 | | |
| Check data | 2018-1-25 | | |