

PACKAGE DIMENSION mm

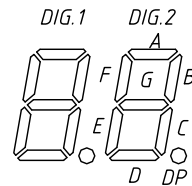

INTERNAL CIRCUIT DIAGRAM

Common Cathode
L-KLS9-D-3024 Ax

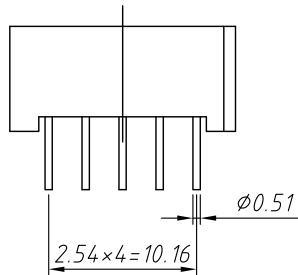
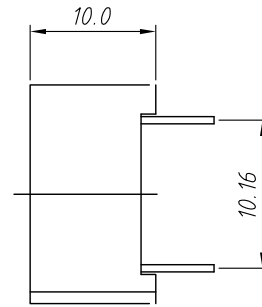
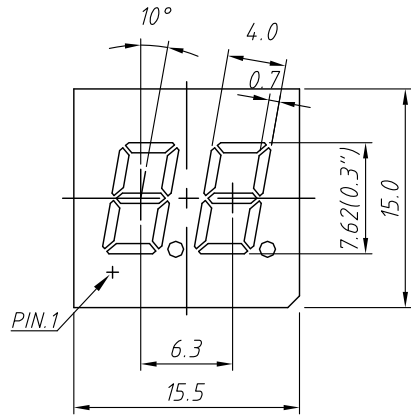
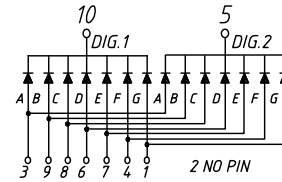

Common Anode
L-KLS9-D-3024 Bx

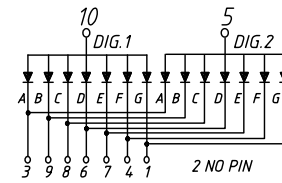

Color Code	Emitting Color	Peak Wavelength nm	Forward Voltage V _F /Seg.		Luminous Intensity I _v /Seg.	
			Typ.	Max.	Min.	Typ.
			V		mcd	
UHR	Ultra Red	640	2	2.5	40	60
UE	Orange	615	2	2.5	40	60
H	Red	623	2.25	2.5	0.4	0.8
YO	Amber	605	2	2.5	40	60
UY	Yellow	590	2	2.5	40	60
UG	Green	568	2.1	2.5	25	40
PG	Pure Green	525	3.3	3.8	150	200
UB	Blue	465	3.3	3.8	40	100
UW	White		3.3	3.8	200	500

Electro/Optical Characteristics I_f=20mA Ta=25°C

Order information

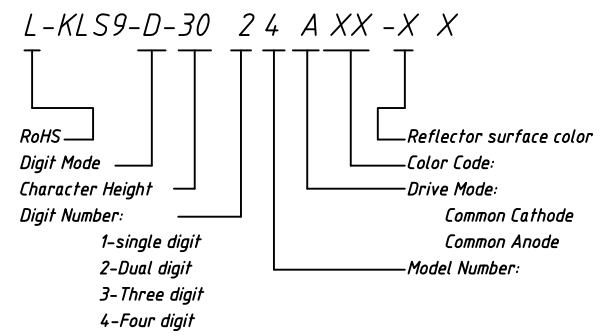

Maximum Ratings Ta=25°C (Derate above 25°C)

Characteristic	Test Condition	Symbol	Units	Ultra Red	Orange	Red	Amber	Yellow	Green	Pure Green	Blue	White
				UHR	UE	H	YO	UY	UG	PG	UB	UW
Pulse Forward Current Per Seg.	1/10 duty cycle 0.1ms Pulse width	I _{FP}	mA	100	100	50	100	100	100	100	100	100
DC Forward Current Per Seg.		I _F	mA	30	30	15	30	30	30	30	30	30
Reverse Current Per Seg.	V _R =5V	I _R	A	10	10	10	10	10	10	10	10	10
Power Dissipation		P _D	mW	65×8	65×8	40×8	65×8	65×8	75×8	110×8	120×8	120×8

Tolerance:	±0.25mm unless stated	Description:	0.3" Single Digit 7 Segment DISPLAYS
PROJECTION		KLS P/N:	L-KLS9-D-3024XXXXX
UNITS	mm	NingBo KLS ELECTRONIC CO.,L TD.	
SHEET SIZE	A4		
Draw data	2018-1-25		
Check data	2018-1-25		