

1 RoHS Compliant

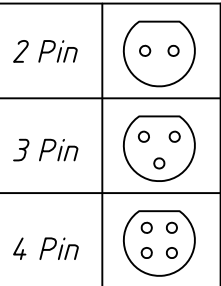
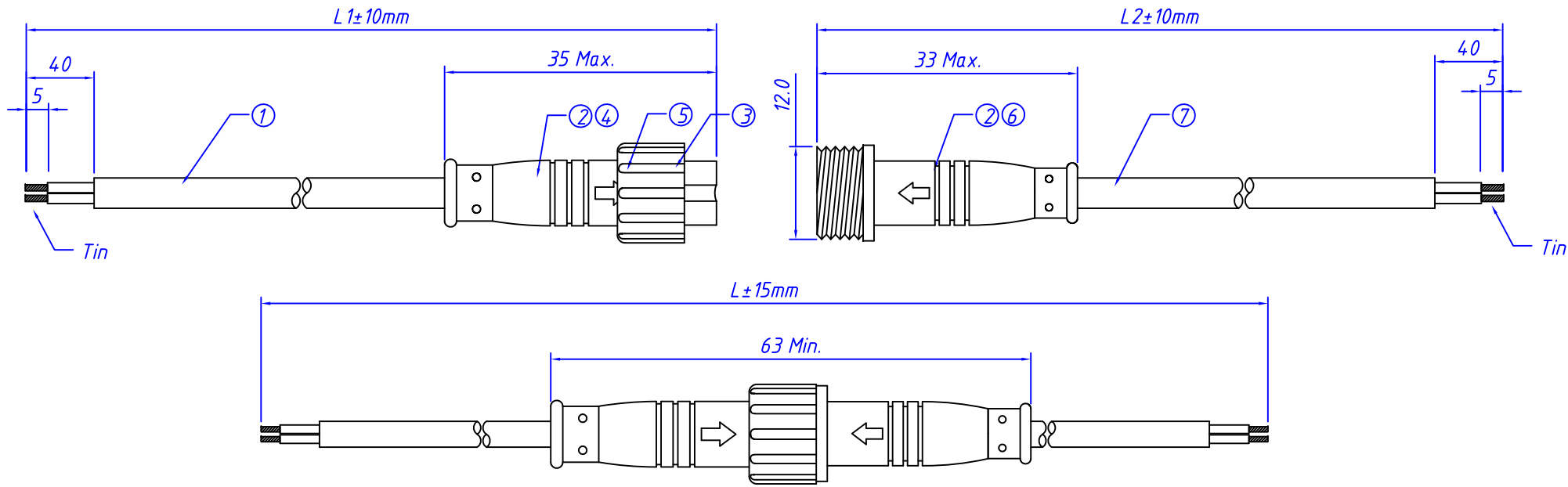

Note
 1: Open/Short Text 100% Text. insulation: Min, 2M
 2: All must be meet on RoHS Compliant

7	Cable	H05VV-F 2x0.5mm ² PVC Cable,Black,OD6.8mm	mm	L2
6	Terminal	Female terminal,Tin plated	PCS	2
5	Nut	M12,PC,Black	PCS	1
4	Terminal	Male terminal,Tin plated	PCS	2
3	Sealing ring	Silicone waterproof circle,Red	PCS	1
2	PVC	PVC 45P MOLDING,Black	g	35x2
1	Cable	H05VV-F 2x0.5mm ² PVC Cable,Black,OD6.8mm	mm	L1
ITEM	PART NAME	Description	UNIT	Q'TY

Order Information:

L-KLS17-LP003-XXX B 2 05 XX

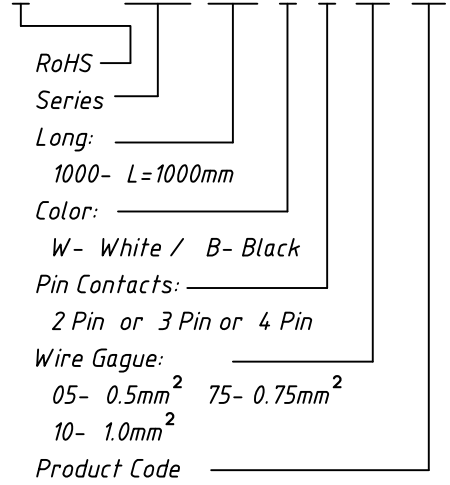

How to order KLS waterproof cable:

- 1-Confirm the cable material
- 2-Connector Contact number & wire size
(2x0.5mm² ,2x0.75mm² ,22AWGx2C ,18AWGx2C ,.....)
- 3-Select form factor
- 4-Determination of length, single-sided length with connector
- 5-Determine the tail handling method
(Stripping, Tin.....)
- 6-Special custom requirements

		Description:	
		M12 waterproof cable ,IP67	
PROJECTION		KLS P/N:	L-KLS17-LP003-XXXXXXXXXX
UNITS	mm		
SHEET SIZE	A4		
Draw:Daniel	2018-09-29		NingBo KLS ELECTRONIC CO.,L TD.
Check:Daniel	2018-09-29		