

1 RoHS Compliance

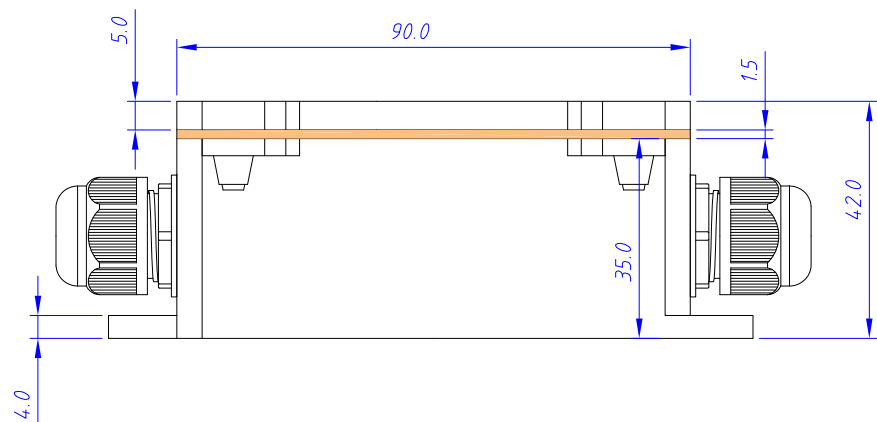
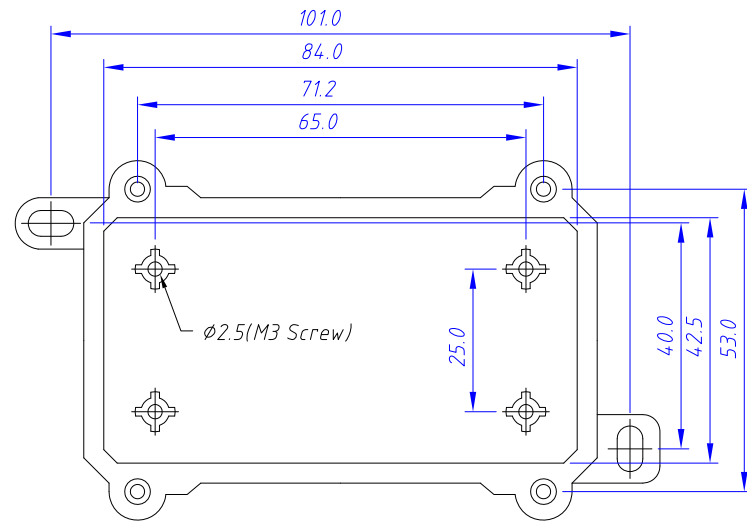
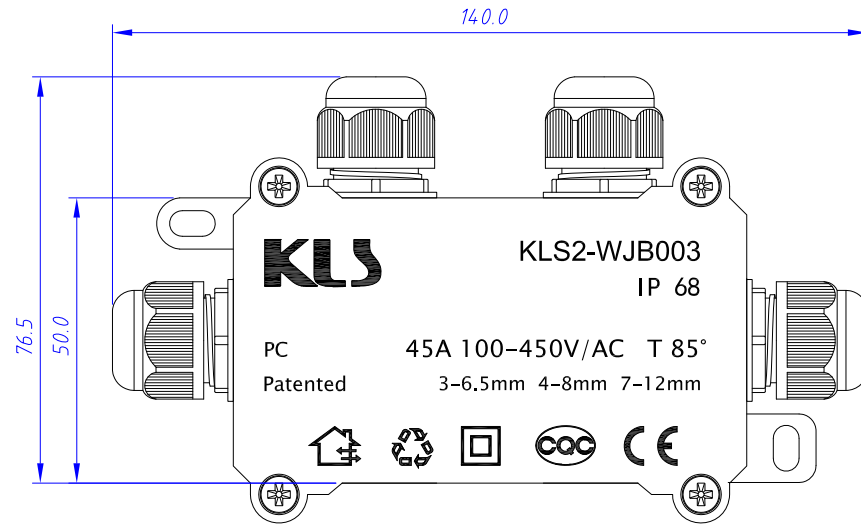

Note

- 1- Internal size: L84×W42.5×H33.5mm
- 2- Material: PC PP
- 3- Waterproof Level: IP68
- 4- Certification: CE CQC SGS

ORDER INFORMATION

L-KLS2-WJB003 -B PG09

Cable Gland	PG7	PG9	PG13.5
Cable OD mm	3-6.5	4-8	7-12

Cable Glands:
Color: B- Black W- White
WATERPROOF BOX Type
RoHS

GENERAL TOLERANCE		ANGLE TOLERANCE	PROJECTION	Description:
X.	±0.60	±2°	UNITS	IP68 WATERPROOF BOX, 101×40×42mm
.X	±0.38		SHEET SIZE	
.XX	±0.25		KLS P/N:	
Draw:	Daniel	2018-08-27	 NingBo KLS ELECTRONIC CO.,L TD.	
Check:	Daniel	2018-08-27		
SCALE		SHEET		