

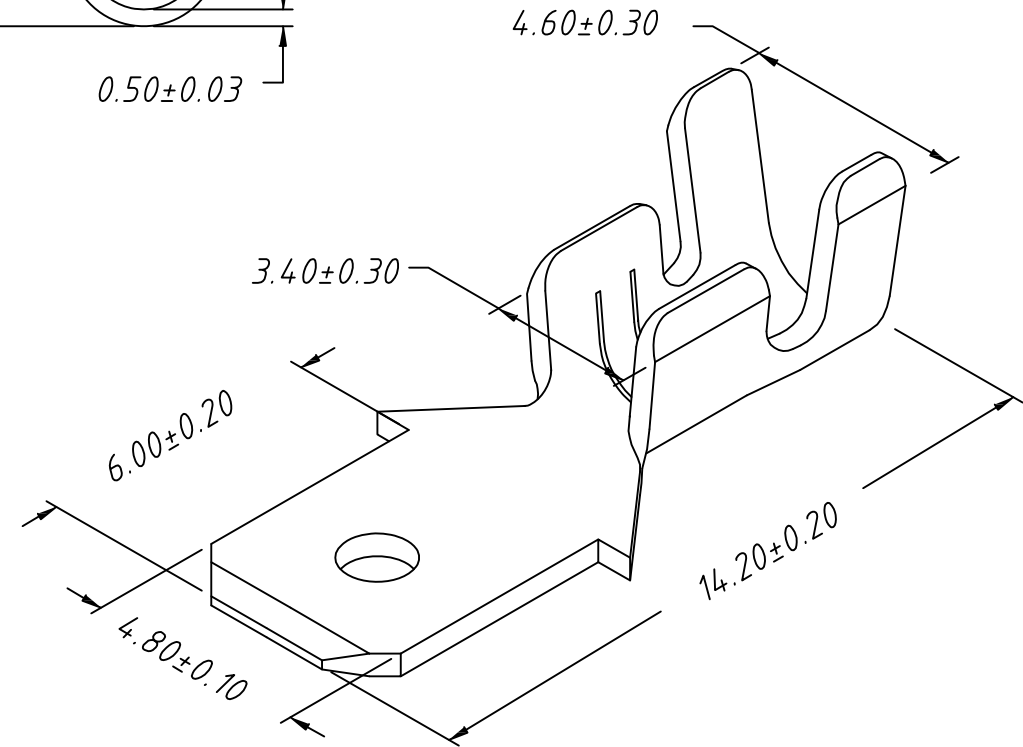

1
RoHS Compliant

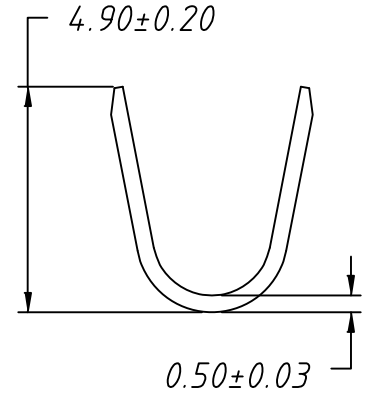
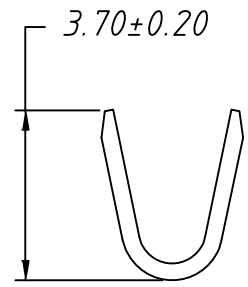

Note:
 1. Appearance: Terminal cannot be corrected, scratched or oxidized
 2. Material: Brass C2680, T=0.50mm, Tin plating
 3. Q'TY: 10000PCS/REEL
 4. Wire Range: 16~20AWG

TOLERANCE		PROJECTION	Description:		
0 - 3mm	±0.10	UNITS	mm		
3 - 6mm	±0.15	SHEET SIZE	A4		
6 - 10mm	±0.20	KLS P/N: KLS8-BMN02-1870500			
10 - 30mm	±0.25	 NingBo KLS ELECTRONIC CO.,L TD.			
Draw:	Daniel			ANGLE	±3°
Check:	Daniel			Data:	2019-04-10