

1
RoHS Compliant

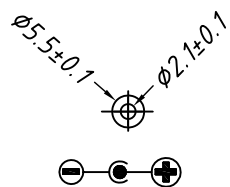
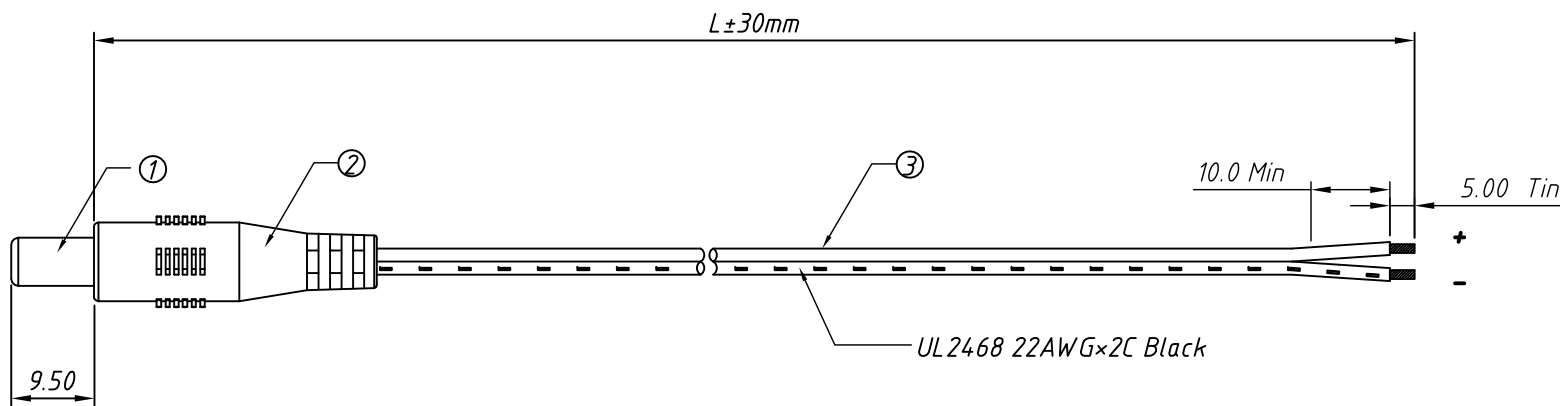

Order Information

L-KLS17-ACP001- 22 B 1000

L: RoHS

ACP001: 5.5×2.1×9.5 DC Male-Tin

22: UL2468 22AWG×2C

B: Color: B- Black W- White

1000: Length 1000=1000mm

1500=1500mm

Note

1:Open/Short Text 100% Text.

2:Text Volts/insulation: DC 5V / 500KΩ

3: All must be meet on RoHS Compliant

3	Cable	UL2468-22AWG×2C,Black	mm	L
2	PVC molding	PVC,BLACK	g	xx
1	Connector	5.5×2.1×9.5 DC Male PLUG	PCS	1
ITEM	PART NAME	Description	UNIT	Q'TY

		Description:	
		5.5×2.1×9.5mm To Tin, DC Male Cable	
PROJECTION		KLS P/N:	L-KLS17-ACP001-22BXXXX
UNITS	mm		
SHEET SIZE	A4		
Draw:Daniel	2018-05-10	NingBo KLS ELECTRONIC CO.,L TD.	
Check:Daniel	2018-05-17		