

RoHS Compliance

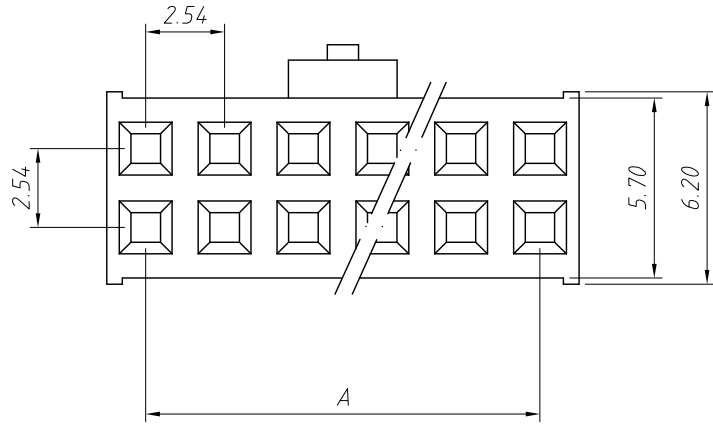

Pin	Dimensions(mm)		Pin	Dimensions(mm)	
	A	B		A	B
2x02	2.54	5.08	2x18	43.18	45.72
2x03	5.08	7.62	2x19	45.72	48.26
2x04	7.62	10.16	2x20	48.26	50.80
2x05	10.16	12.70	2x21	50.80	53.34
2x06	12.70	15.24	2x22	53.34	55.88
2x07	15.24	17.78	2x23	55.88	58.42
2x08	17.78	20.32	2x24	58.42	60.96
2x09	20.32	22.86	2x25	60.96	63.50
2x10	22.86	25.40	2x26	63.50	66.04
2x11	25.40	27.94	2x27	66.04	68.58
2x12	27.94	30.48	2x28	68.58	71.12
2x13	30.48	32.02	2x29	71.12	73.66
2x14	32.02	35.56	2x30	73.66	76.20
2x15	35.56	38.10	2x31	76.20	78.74
2x16	38.10	40.64	2x32	78.74	81.28
2x17	40.64	43.18			

Material:
Housing:PBT,UL 94 V-0,Black

Electrical Characteristics:
Rated Current:3.0AMP
Voltage rating:250V AC,DC
Temperature range:-25°C ~ + 85°C
Insulator Resistance:1000MΩ Min
Withstanding Voltage:1500V AC/minute
Contact Resistance:20mΩ Max

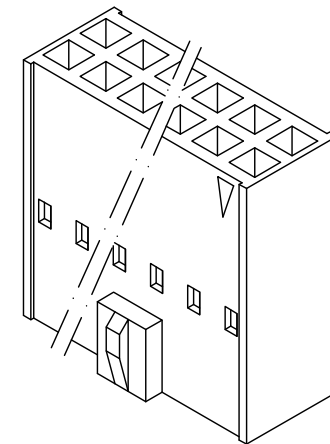
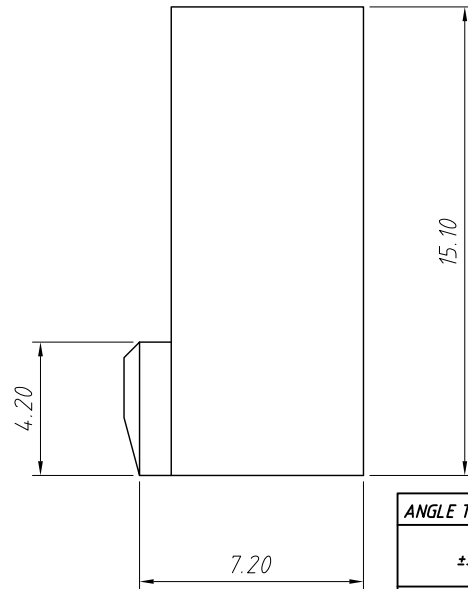
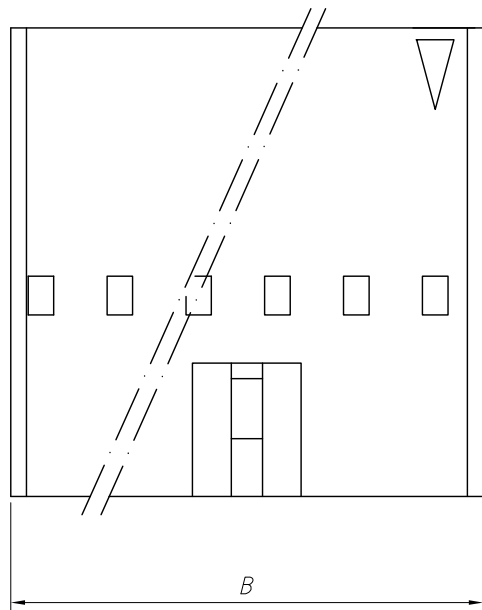

Order Information:
L-KLS1-XL7-2.54-XX-H1

L: RoHS
Pitch:2.54mm
XX-No. of 04 ~ 64pins
Type: _____
H1/H2/H3/H4-Housing T-Terminal
S-Straight male pin
R-Right angle male pin

ANGLE TOLERANCE	PROJECTION	Description:	2.54mm Pitch C-Grid III Wire To Board Connector
±3°			
GENERAL TOLERANCE	UNITS	mm	KLS P/N:
x.x ±0.30	SHEET SIZE	A4	L-KLS1-XL7-2.54-XX-H1
x.xx ±0.20	Draw:	Daniel	2021-01-11
x.xxx ±0.10	Check:	Daniel	2021-01-11



NingBo KLS ELECTRONIC CO.,L TD.

RoHS Compliance

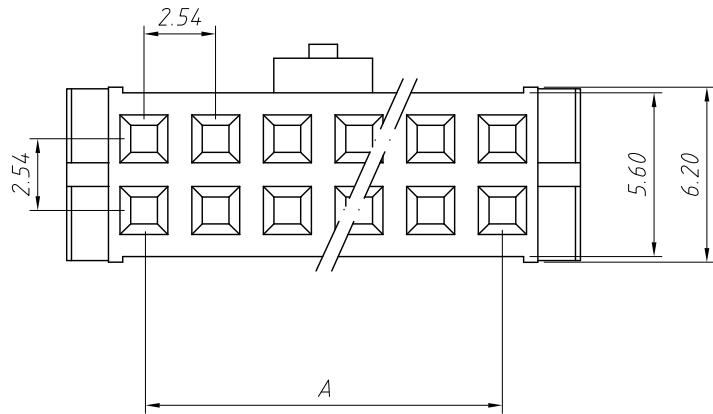

Pin	Dimensions(mm)		Pin	Dimensions(mm)	
	A	B		A	B
2×02	2.54	5.08	2×18	43.18	45.72
2×03	5.08	7.62	2×19	45.72	48.26
2×04	7.62	10.16	2×20	48.26	50.80
2×05	10.16	12.70	2×21	50.80	53.34
2×06	12.70	15.24	2×22	53.34	55.88
2×07	15.24	17.78	2×23	55.88	58.42
2×08	17.78	20.32	2×24	58.42	60.96
2×09	20.32	22.86	2×25	60.96	63.50
2×10	22.86	25.40	2×26	63.50	66.04
2×11	25.40	27.94	2×27	66.04	68.58
2×12	27.94	30.48	2×28	68.58	71.12
2×13	30.48	32.02	2×29	71.12	73.66
2×14	32.02	35.56	2×30	73.66	76.20
2×15	35.56	38.10	2×31	76.20	78.74
2×16	38.10	40.64	2×32	78.74	81.28
2×17	40.64	43.18			

Material:
Housing:PBT,UL 94 V-0,Black

Electrical Characteristics:
Rated Current:3.0AMP
Voltage rating:250V AC,DC
Temperature range:-25°C ~ + 85°C
Insulator Resistance:1000MΩ Min
Withstanding Voltage:1500V AC/minute
Contact Resistance:20mΩ Max

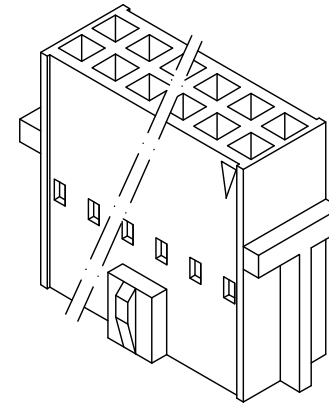
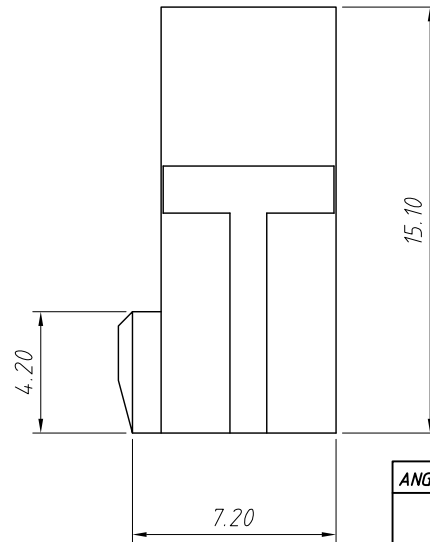
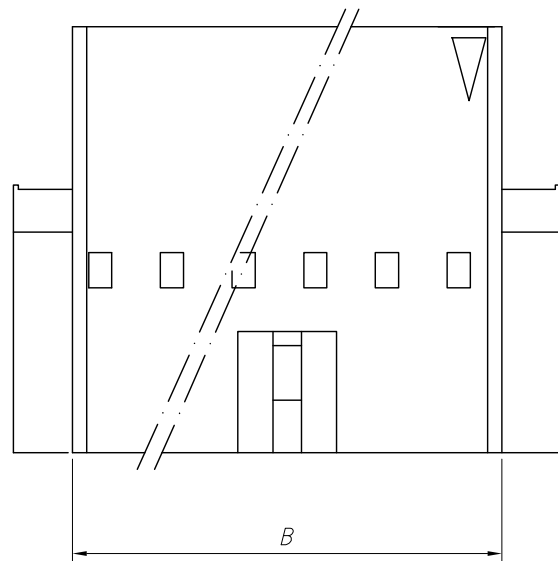

Order Information:
L-KLS1-XL7-2.54-XX-H2

L: RoHS
Pitch:2.54mm
XX-No. of 04 ~ 64pins
Type:
H1/H2/H3/H4-Hosing T-Terminal
S-Straight male pin
R-Right angle male pin

ANGLE TOLERANCE	PROJECTION	Description:	2.54mm Pitch C-Grid III Wire To Board Connector
±3°			
GENERAL TOLERANCE	UNITS	mm	KLS P/N:
x.x ±0.30	SHEET SIZE	A4	L-KLS1-XL7-2.54-XX-H2
x.xx ±0.20	Draw:	Daniel	2021-01-11
x.xxx ±0.10	Check:	Daniel	2021-01-11



NingBo KLS ELECTRONIC CO.,L TD.

1
RoHS Compliance

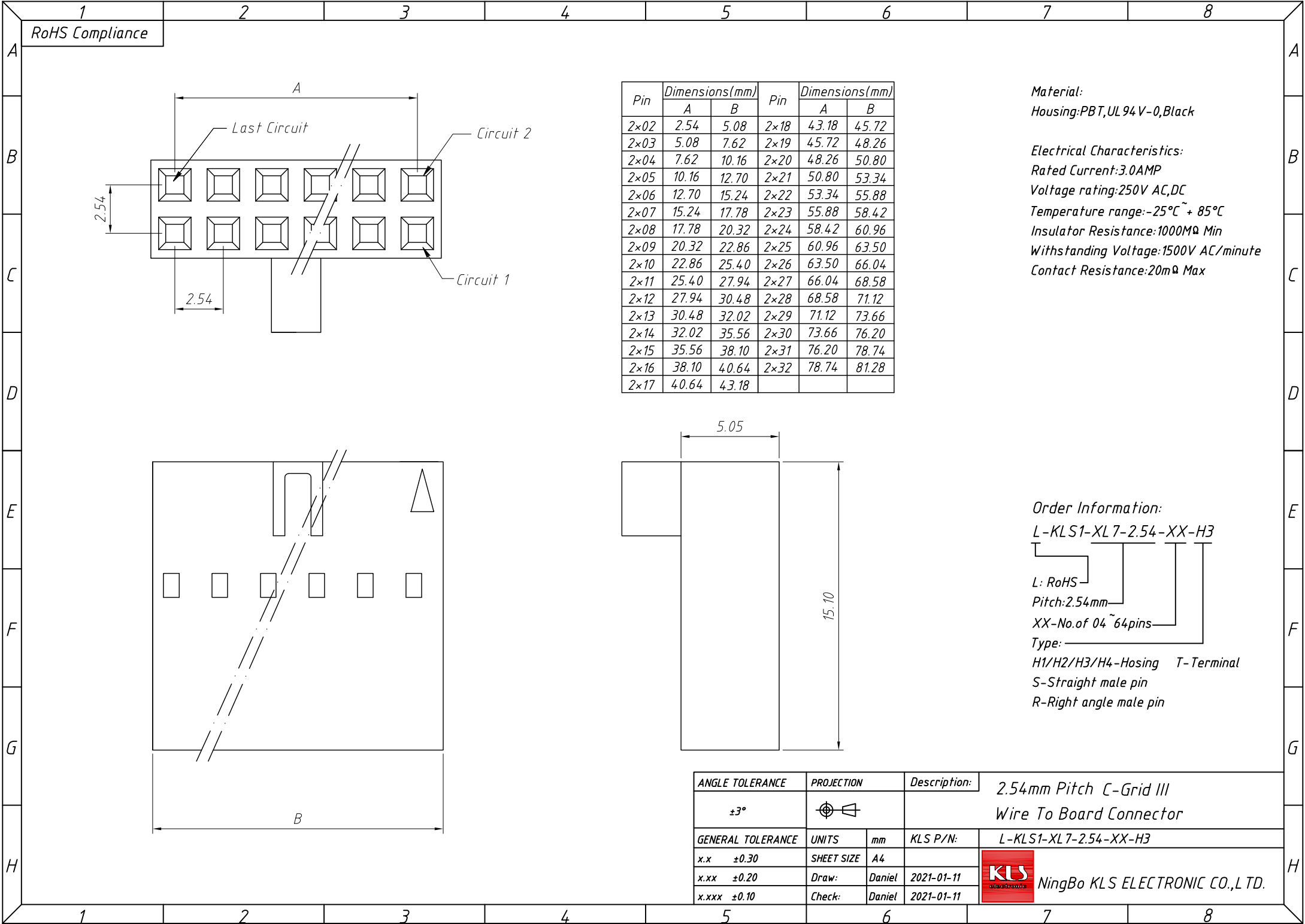

Pin	Dimensions(mm)		Pin	Dimensions(mm)	
	A	B		A	B
2x02	2.54	5.08	2x18	43.18	45.72
2x03	5.08	7.62	2x19	45.72	48.26
2x04	7.62	10.16	2x20	48.26	50.80
2x05	10.16	12.70	2x21	50.80	53.34
2x06	12.70	15.24	2x22	53.34	55.88
2x07	15.24	17.78	2x23	55.88	58.42
2x08	17.78	20.32	2x24	58.42	60.96
2x09	20.32	22.86	2x25	60.96	63.50
2x10	22.86	25.40	2x26	63.50	66.04
2x11	25.40	27.94	2x27	66.04	68.58
2x12	27.94	30.48	2x28	68.58	71.12
2x13	30.48	32.02	2x29	71.12	73.66
2x14	32.02	35.56	2x30	73.66	76.20
2x15	35.56	38.10	2x31	76.20	78.74
2x16	38.10	40.64	2x32	78.74	81.28
2x17	40.64	43.18			

Material:
Housing:PBT,UL 94 V-0,Black

Electrical Characteristics:
Rated Current:3.0AMP
Voltage rating:250V AC,DC
Temperature range:-25°C ~ + 85°C
Insulator Resistance:1000MΩ Min
Withstanding Voltage:1500V AC/minute
Contact Resistance:20mΩ Max

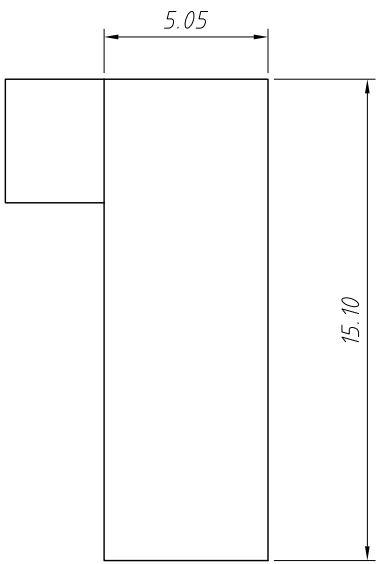

Order Information:
L-KLS1-XL7-2.54-XX-H3

L: RoHS
Pitch:2.54mm
XX-No.of 04~64pins
Type:
H1/H2/H3/H4-Hosing T-Terminal
S-Straight male pin
R-Right angle male pin

ANGLE TOLERANCE	PROJECTION	Description:	2.54mm Pitch C-Grid III Wire To Board Connector
±3°			
GENERAL TOLERANCE	UNITS	mm	KLS P/N: L-KLS1-XL7-2.54-XX-H3
x.x ±0.30	SHEET SIZE	A4	
x.xx ±0.20	Draw:	Daniel	2021-01-11
x.xxx ±0.10	Check:	Daniel	2021-01-11

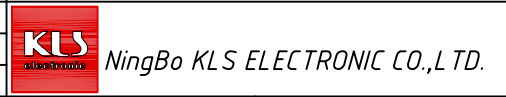

RoHS Compliance

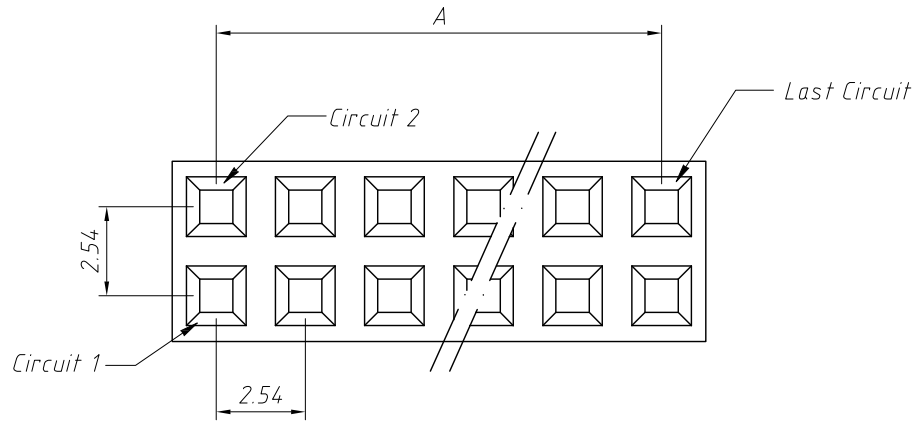

Pin	Dimensions(mm)		Pin	Dimensions(mm)	
	A	B		A	B
2×02	2.54	5.08	2×18	43.18	45.72
2×03	5.08	7.62	2×19	45.72	48.26
2×04	7.62	10.16	2×20	48.26	50.80
2×05	10.16	12.70	2×21	50.80	53.34
2×06	12.70	15.24	2×22	53.34	55.88
2×07	15.24	17.78	2×23	55.88	58.42
2×08	17.78	20.32	2×24	58.42	60.96
2×09	20.32	22.86	2×25	60.96	63.50
2×10	22.86	25.40	2×26	63.50	66.04
2×11	25.40	27.94	2×27	66.04	68.58
2×12	27.94	30.48	2×28	68.58	71.12
2×13	30.48	32.02	2×29	71.12	73.66
2×14	32.02	35.56	2×30	73.66	76.20
2×15	35.56	38.10	2×31	76.20	78.74
2×16	38.10	40.64	2×32	78.74	81.28
2×17	40.64	43.18			

Material:
Housing: PBT, UL 94 V-0, Black

Electrical Characteristics:
Rated Current: 3.0AMP
Voltage rating: 250V AC, DC
Temperature range: -25°C ~ +85°C
Insulator Resistance: 1000MΩ Min
Withstanding Voltage: 1500V AC/minute
Contact Resistance: 20mΩ Max

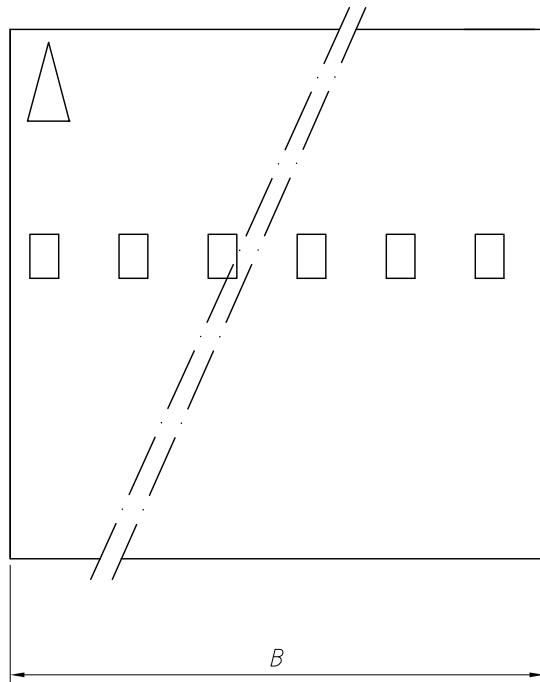

Order Information:
L-KLS1-XL7-2.54-XX-H4
L: RoHS
Pitch: 2.54mm
XX-No. of 04~64pins
Type: _____
H1/H2/H3/H4-Housing T-Terminal
S-Straight male pin
R-Right angle male pin

ANGLE TOLERANCE	PROJECTION	Description:
±3°		2.54mm Pitch C-Grid III Wire To Board Connector
GENERAL TOLERANCE	UNITS	mm
x.x ±0.30	SHEET SIZE	A4
x.xx ±0.20	Draw:	Daniel 2021-01-11
x.xxx ±0.10	Check:	Daniel 2021-01-11

NingBo KLS ELECTRONIC CO.,L TD.

1
RoHS Compliance

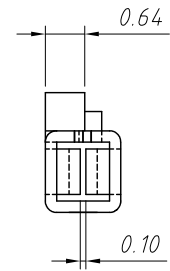
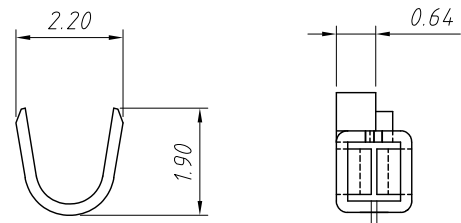
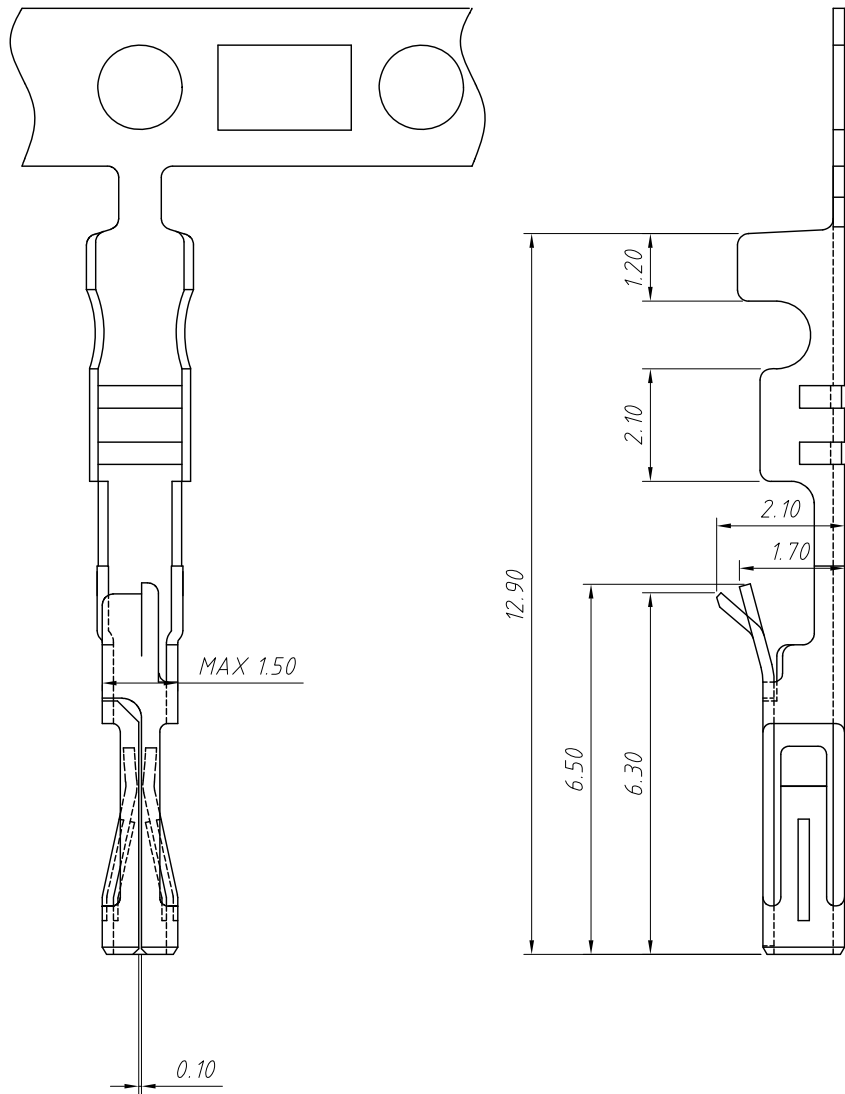

Material:
 Terminal: Phosphor Bronze
 Plating: Tin plated over Gold plated
 Applicable wires: AWG #26 ~ #22
 Insulation O.D: 1.60mm
 Qty/reel: 15000 pcs

Electrical Characteristics:
 Rated Current: 3.0AMP
 Voltage rating: 250V AC, DC
 Temperature range: -25°C ~ +85°C
 Insulator Resistance: 1000MΩ Min
 Withstanding Voltage: 1500V AC/minute
 Contact Resistance: 20mΩ Max

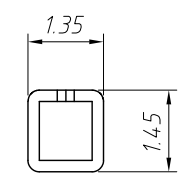
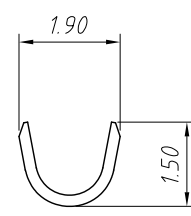

Order Information:
 L-KLS1-XL7-2.54-T
 L: RoHS
 Pitch: 2.54mm
 Type:
 H1/H2/H3/H4-Hosing T-Terminal
 S-Straight male pin
 R-Right angle male pin

ANGLE TOLERANCE	PROJECTION	Description:	2.54mm Pitch C-Grid III Wire To Board Connector
±3°			
GENERAL TOLERANCE	UNITS	mm	KLS P/N: L-KLS1-XL7-2.54-T
x.x ±0.30	SHEET SIZE	A4	NingBo KLS ELECTRONIC CO.,LTD.
x.xx ±0.20	Draw:	Daniel 2021-01-11	
x.xxx ±0.10	Check:	Daniel 2021-01-11	

1 RoHS Compliance

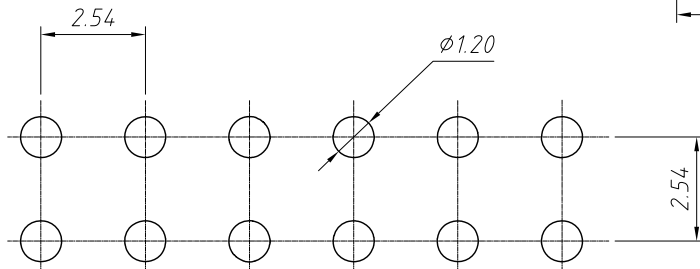
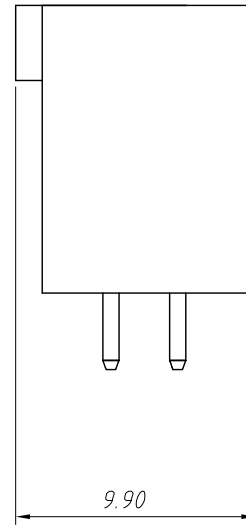
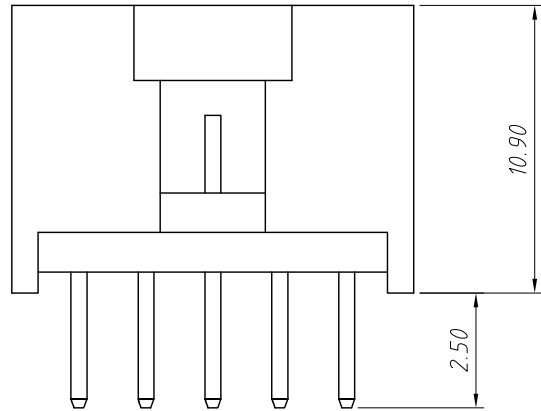
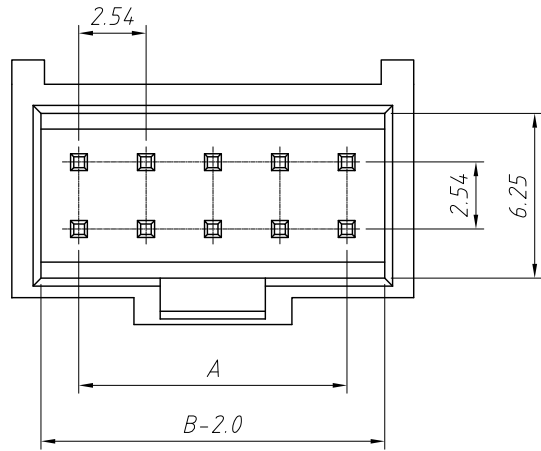

Pin	Dimensions(mm)		Pin	Dimensions(mm)	
	A	B		A	B
2x03	5.08	10.12	2x18	43.18	48.22
2x04	7.62	12.66	2x19	45.72	50.76
2x05	10.16	15.20	2x20	48.26	53.30
2x06	12.70	17.74	2x21	50.80	55.84
2x07	15.24	20.28	2x22	53.34	58.38
2x08	17.78	22.82	2x23	55.88	60.92
2x09	20.32	25.36	2x24	58.42	63.46
2x10	22.86	27.90	2x25	60.96	66.00
2x11	25.40	30.44	2x26	63.50	68.54
2x12	27.94	32.98	2x27	66.04	71.08
2x13	30.48	35.52	2x28	68.58	73.62
2x14	32.02	38.06	2x29	71.12	76.16
2x15	35.56	40.60	2x30	73.66	78.70
2x16	38.10	43.14	2x31	76.20	81.24
2x17	40.64	45.68	2x32	78.74	83.78

Material:
Housing: PBT, UL 94 V-0, Black
Pin: Brass
Plating: Tin plated over Gold plated

Electrical Characteristics:
Rated Current: 3.0AMP
Voltage rating: 250V AC, DC
Temperature range: -25°C ~ +85°C
Insulator Resistance: 1000M Ω Min
Withstanding Voltage: 1500V AC/minute
Contact Resistance: 20m Ω Max

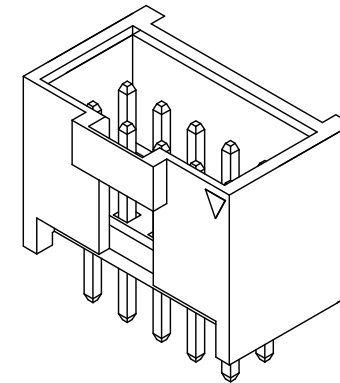

Order Information:
L-KLS1-XL7-2.54-XX-S
L: RoHS
Pitch: 2.54mm
XX-No. of 06~64 pins
Type: _____
H1/H2/H3/H4-Housing T-Terminal
S-Straight male pin
R-Right angle male pin

ANGLE TOLERANCE	PROJECTION	Description:
$\pm 3^\circ$		2.54mm Pitch C-Grid III Wire To Board Connector
GENERAL TOLERANCE	UNITS	mm
x.x ± 0.30	SHEET SIZE	A4
x.xx ± 0.20	Draw:	Daniel 2021-01-11
x.xxx ± 0.10	Check:	Daniel 2021-01-11

L-KLS1-XL7-2.54-XX-S

NingBo KLS ELECTRONIC CO.,L TD.

1 RoHS Compliance

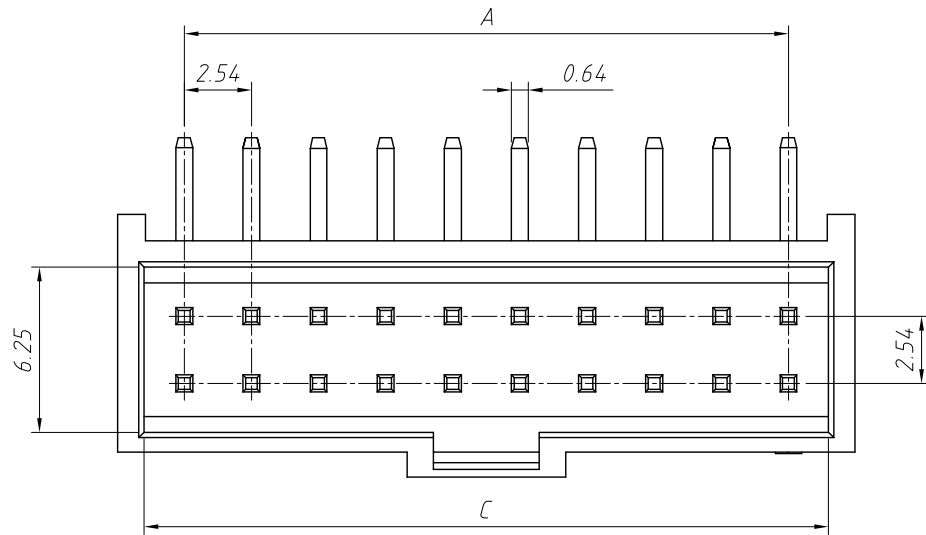

Pin	Dimensions(mm)		Pin	Dimensions(mm)	
	A	B		A	B
2×03	5.08	10.12	2×18	43.18	48.22
2×04	7.62	12.66	2×19	45.72	50.76
2×05	10.16	15.20	2×20	48.26	53.30
2×06	12.70	17.74	2×21	50.80	55.84
2×07	15.24	20.28	2×22	53.34	58.38
2×08	17.78	22.82	2×23	55.88	60.92
2×09	20.32	25.36	2×24	58.42	63.46
2×10	22.86	27.90	2×25	60.96	66.00
2×11	25.40	30.44	2×26	63.50	68.54
2×12	27.94	32.98	2×27	66.04	71.08
2×13	30.48	35.52	2×28	68.58	73.62
2×14	32.02	38.06	2×29	71.12	76.16
2×15	35.56	40.60	2×30	73.66	78.70
2×16	38.10	43.14	2×31	76.20	81.24
2×17	40.64	45.68	2×32	78.74	83.78

Material:
Housing:PBT,UL94V-0,Black
Pin:Brass
Plating: Tin plated over Gold plated

Electrical Characteristics:
Rated Current:3.0AMP
Voltage rating:250V AC,DC
Temperature range:-25°C ~ + 85°C
Insulator Resistance:1000MΩ Min
Withstanding Voltage:1500V AC/minute
Contact Resistance:20mΩ Max

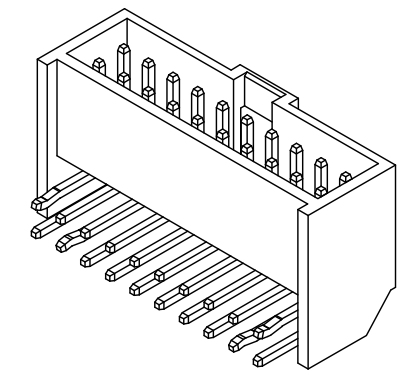

Order Information:
L-KLS1-XL7-2.54-XX-R
L: RoHS
Pitch:2.54mm
XX-No. of 06 ~ 64pins
Type:
H1/H2/H3/H4-Hosing T-Terminal
S-Straight male pin
R-Right angle male pin

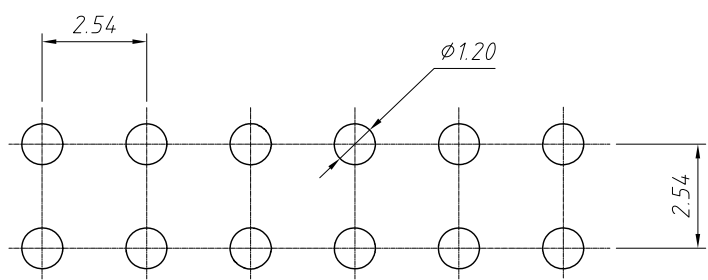
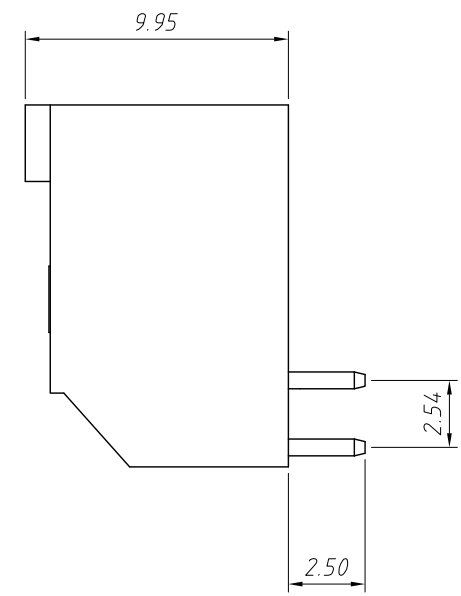
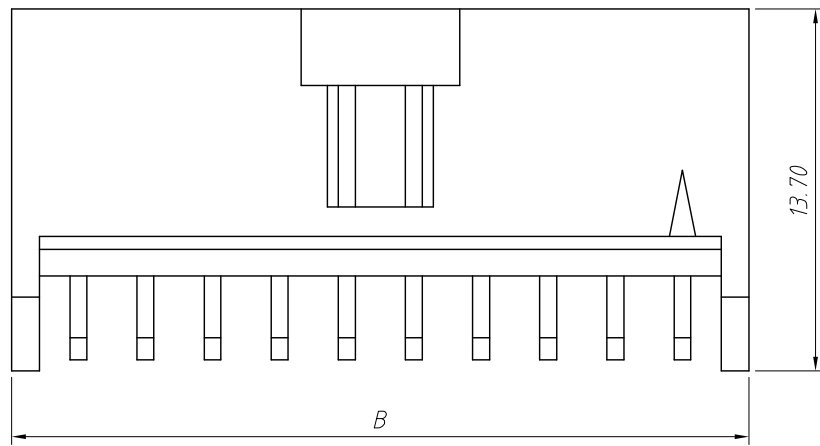

ANGLE TOLERANCE	PROJECTION	Description:
±3°		2.54mm Pitch C-Grid III Wire To Board Connector
GENERAL TOLERANCE	UNITS	mm
x.x ±0.30	SHEET SIZE	A4
x.xx ±0.20	Draw:	Daniel 2021-01-11
x.xxx ±0.10	Check:	Daniel 2021-01-11

L-KLS1-XL7-2.54-XX-R

NingBo KLS ELECTRONIC CO.,L TD.